

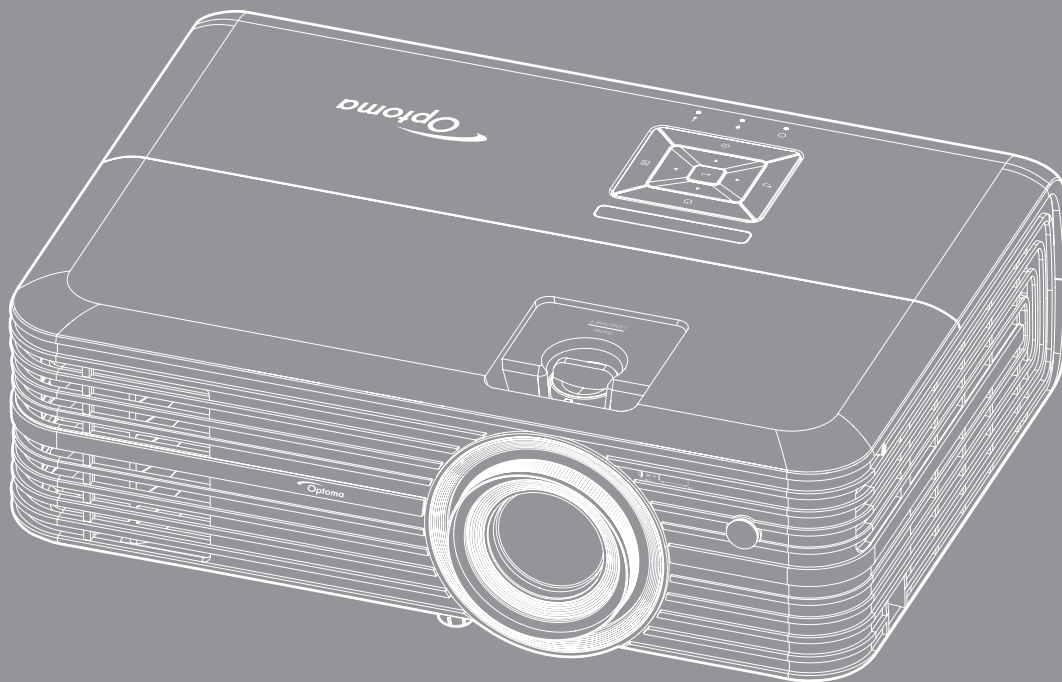

DLP® Projector



User manual





TABLE OF CONTENTS

SAFETY	4
<i>Important Safety Instruction.....</i>	<i>4</i>
<i>3D Safety Information.....</i>	<i>5</i>
<i>Copyright.....</i>	<i>6</i>
<i>Disclaimer.....</i>	<i>6</i>
<i>Trademark Recognition</i>	<i>6</i>
<i>FCC</i>	<i>7</i>
<i>Declaration of Conformity for EU countries</i>	<i>7</i>
<i>WEEE.....</i>	<i>7</i>
INTRODUCTION.....	8
<i>Package Overview.....</i>	<i>8</i>
<i>Standard accessories.....</i>	<i>8</i>
<i>Optional accessories.....</i>	<i>8</i>
<i>Product Overview</i>	<i>9</i>
<i>Connections.....</i>	<i>10</i>
<i>Keypad</i>	<i>11</i>
<i>Remote control.....</i>	<i>12</i>
SETUP AND INSTALLATION.....	13
<i>Installing the projector</i>	<i>13</i>
<i>Connecting sources to the projector.....</i>	<i>14</i>
<i>Adjusting the projector image.....</i>	<i>15</i>
<i>Remote setup</i>	<i>16</i>
USING THE PROJECTOR.....	18
<i>Powering on / off the projector.....</i>	<i>18</i>
<i>Selecting an input source</i>	<i>20</i>
<i>Home screen overview.....</i>	<i>21</i>
<i>Projector settings.....</i>	<i>22</i>
<i>Application settings.....</i>	<i>35</i>
<i>General settings</i>	<i>47</i>
MAINTENANCE.....	53
<i>Replacing the lamp.....</i>	<i>53</i>
<i>Installing and cleaning the dust filter</i>	<i>55</i>

ADDITIONAL INFORMATION 56

<i>Compatible resolutions</i>	56
<i>Image size and projection distance</i>	58
<i>Projector dimensions and ceiling mount installation</i>	59
<i>IR remote codes</i>	60
<i>Troubleshooting</i>	61
<i>Warning indicators</i>	63
<i>Specifications</i>	65
<i>Configuring Alexa with the projector</i>	66
<i>Optoma global offices</i>	73

SAFETY

	The lightning flash with arrow head within an equilateral triangle is intended to alert the user to the presence of uninsulated "dangerous voltage" within the product's enclosure that may be of sufficient magnitude to constitute a risk of electric shock to persons.
	The exclamation point within an equilateral triangle is intended to alert the user to the presence of important operating and maintenance (servicing) instructions in the literature accompanying the appliance.

Please follow all warnings, precautions and maintenance as recommended in this user's guide.

Important Safety Instruction

- To prolong the effective life of the lamp, make sure to keep the lamp on for at least 60 seconds and avoid performing force shutdown.

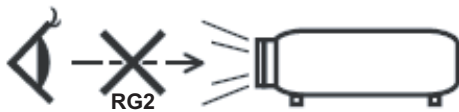

- Do not stare into the beam, RG2.
As with any bright source, do not stare into the direct beam, RG2 IEC 62471-5:2015.
- Do not block any ventilation openings. To ensure reliable operation of the projector and to protect from over heating, it is recommended to install the projector in a location that does not block ventilation. As an example, do not place the projector on a crowded coffee table, sofa, bed, etc. Do not put the projector in an enclosure such as a book case or a cabinet that restricts air flow.
- To reduce the risk of fire and/or electric shock, do not expose the projector to rain or moisture. Do not install near heat sources such as radiators, heaters, stoves or any other apparatus such as amplifiers that emits heat.
- Do not let objects or liquids enter the projector. They may touch dangerous voltage points and short out parts that could result in fire or electric shock.
- Do not use under the following conditions:
 - In extremely hot, cold or humid environments.
 - (i) Ensure that the ambient room temperature is within 5°C ~ 40°C
 - (ii) Relative humidity is 10% ~ 85%
 - In areas susceptible to excessive dust and dirt.
 - Near any appliance generating a strong magnetic field.
 - In direct sunlight.
- Do not use the projector in places where flammable gases or explosives gases may be present in the atmosphere. The lamp inside the projector becomes very hot during operation and the gases may ignite and result in a fire.
- Do not use the unit if it has been physically damaged or abused. Physical damage/abuse would be (but not limited to):
 - Unit has been dropped.
 - Power supply cord or plug has been damaged.
 - Liquid has been spilled on to the projector.
 - Projector has been exposed to rain or moisture.
 - Something has fallen in the projector or something is loose inside.
- Do not place the projector on an unstable surface. The projector may fall over resulting in injury or the projector may become damaged.

- Do not block the light coming out of the projector lens when in operation. The light will heat the object and could melt, cause burns or start a fire.
 - Please do not open or disassemble the projector as this may cause electric shock.
 - Do not attempt to service the unit yourself. Opening or removing covers may expose you to dangerous voltages or other hazards. Please call Optoma before you send the unit for repair.
 - See projector enclosure for safety related markings.
 - The unit should only be repaired by appropriate service personnel.
 - Only use attachments/accessories specified by the manufacturer.
 - Do not look straight into the projector lens during operation. The bright light may harm your eyes.
 - When replacing the lamp, please allow the unit to cool down. Follow instructions as described on pages 52-53.
 - This projector will detect the life of the lamp itself. Please be sure to change the lamp when it shows warning messages.
 - Reset the "Lamp Reset" function from the on-screen display "Lamp Settings" menu after replacing the lamp module.
 - When switching the projector off, please ensure the cooling cycle has been completed before disconnecting power. Allow 90 seconds for the projector to cool down.
 - When the lamp is approaching to the end of its life time, the message "Lamp life exceeded." will show on the screen. Please contact your local reseller or service center to change the lamp as soon as possible.
 - Turn off and unplug the power plug from the AC outlet before cleaning the product.
 - Use a soft dry cloth with mild detergent to clean the display housing. Do not use abrasive cleaners, waxes or solvents to clean the unit.
 - Disconnect the power plug from AC outlet if the product is not being used for a long period of time.
- Note:** *When the lamp reaches the end of its life, the projector will not turn back on until the lamp module has been replaced. To replace the lamp, follow the procedures listed under "Replacing the Lamp" section on pages 52-53.*
- *Do not setup the projector in places where it might be subjected to vibration or shock.*
 - *Do not touch the lens with bare hands.*
 - *Remove battery/batteries from remote control before storage. If the battery/batteries are left in the remote for long periods, they may leak.*
 - *Do not use or store the projector in places where smoke from oil or cigarettes may be present, as it can adversely affect the quality of the projector performance.*
 - *Please follow the correct projector orientation installation as non standard installation may affect the projector performance.*
 - *Use a power strip and or surge protector. As power outages and brown-outs can KILL devices.*

3D Safety Information

Please follow all warnings and precautions as recommended before you or your child use the 3D function.

Warning

Children and teenagers may be more susceptible to health issues associated with viewing in 3D and should be closely supervised when viewing these images.

Photosensitive Seizure Warning and Other Health Risks

- Some viewers may experience an epileptic seizure or stroke when exposed to certain flashing images or lights contained in certain Projector pictures or video games. If you suffer from, or have a family history of epilepsy or strokes, please consult with a medical specialist before using the 3D function.
- Even those without a personal or family history of epilepsy or stroke may have an undiagnosed condition that can cause photosensitive epileptic seizures.

- Pregnant women, the elderly, sufferers of serious medical conditions, those who are sleep deprived or under the influence of alcohol should avoid utilizing the unit's 3D functionality.
- If you experience any of the following symptoms, stop viewing 3D pictures immediately and consult a medical specialist: (1) altered vision; (2) light-headedness; (3) dizziness; (4) involuntary movements such as eye or muscle twitching; (5) confusion; (6) nausea; (7) loss of awareness; (8) convulsions; (9) cramps; and/ or (10) disorientation. Children and teenagers may be more likely than adults to experience these symptoms. Parents should monitor their children and ask whether they are experiencing these symptoms.
- Watching 3D projection may also cause motion sickness, perceptual after effects, disorientation, eye strain and decreased postural stability. It is recommended that users take frequent breaks to lessen the potential of these effects. If your eyes show signs of fatigue or dryness or if you have any of the above symptoms, immediately discontinue use of this device and do not resume using it for at least thirty minutes after the symptoms have subsided.
- Watching 3D projection while sitting too close to the screen for an extended period of time may damage your eyesight. The ideal viewing distance should be at least three times the screen height. It is recommended that the viewer's eyes are level with the screen.
- Watching 3D projection while wearing 3D glasses for an extended period of time may cause a headache or fatigue. If you experience a headache, fatigue or dizziness, stop viewing the 3D projection and rest.
- Do not use the 3D glasses for any other purpose than for watching 3D projection.
- Wearing the 3D glasses for any other purpose (as general spectacles, sunglasses, protective goggles, etc.) may be physically harmful to you and may weaken your eyesight.
- Viewing in 3D projection may cause disorientation for some viewers. Accordingly, DO NOT place your 3D PROJECTOR near open stairwells, cables, balconies, or other objects that can be tripped over, run into, knocked down, broken or fallen over.

Copyright

This publication, including all photographs, illustrations and software, is protected under international copyright laws, with all rights reserved. Neither this manual, nor any of the material contained herein, may be reproduced without written consent of the author.

© Copyright 2018

Disclaimer

The information in this document is subject to change without notice. The manufacturer makes no representations or warranties with respect to the contents hereof and specifically disclaims any implied warranties of merchantability or fitness for any particular purpose. The manufacturer reserves the right to revise this publication and to make changes from time to time in the content hereof without obligation of the manufacturer to notify any person of such revision or changes.

Trademark Recognition

Kensington is a U.S. registered trademark of ACCO Brand Corporation with issued registrations and pending applications in other countries throughout the world.

HDMI, the HDMI Logo, and High-Definition Multimedia Interface are trademarks or registered trademarks of HDMI Licensing LLC in the United States and other countries.

DLP®, DLP Link and the DLP logo are registered trademarks of Texas Instruments and BrilliantColor™ is a trademark of Texas Instruments.

Amazon, Alexa and all related logos are trademarks of Amazon.com, Inc. or its affiliates.

All other product names used in this manual are the properties of their respective owners and are Acknowledged.

FCC

This device has been tested and found to comply with the limits for a Class B digital device pursuant to Part 15 of the FCC rules. These limits are designed to provide reasonable protection against harmful interference in a residential installation. This device generates, uses and can radiate radio frequency energy and, if not installed and used in accordance with the instructions, may cause harmful interference to radio communications.

However, there is no guarantee that interference will not occur in a particular installation. If this device does cause harmful interference to radio or television reception, which can be determined by turning the device off and on is encouraged to try to correct the interference by one or more of the following measures:

- Reorient or relocate the receiving antenna.
- Increase the separation between the device and receiver.
- Connect the device into an outlet on a circuit different from that to which the receiver is connected.
- Consult the dealer or an experienced radio/television technician for help.

Notice: Shielded cables

All connections to other computing devices must be made using shielded cables to maintain compliance with FCC regulations.

Caution

Changes or modifications not expressly approved by the manufacturer could void the user's authority, which is granted by the Federal Communications Commission, to operate this projector.

Operation Conditions

This device complies with Part 15 of the FCC Rules. Operation is subject to the following two conditions:

1. This device may not cause harmful interference and
2. This device must accept any interference received, including interference that may cause undesired operation.

Notice: Canadian users

This Class B digital apparatus complies with Canadian ICES-003.

Remarque à l'intention des utilisateurs canadiens

Cet appareil numérique de la classe B est conforme à la norme NMB-003 du Canada.

Declaration of Conformity for EU countries

- EMC Directive 2014/30/EC (including amendments)
- Low Voltage Directive 2014/35/EC
- R & TTE Directive 1999/5/EC (if product has RF function)

WEEE



Disposal instructions

Do not throw this electronic device into the trash when discarding. To minimize pollution and ensure utmost protection of the global environment, please recycle it.

INTRODUCTION

Package Overview

Carefully unpack and verify that you have the items listed below under standard accessories. Some of the items under optional accessories may not be available depending on the model, specification and your region of purchase. Please check with your place of purchase. Some accessories may vary from region to region.

The warranty card is only supplied in some specific regions. Please consult your dealer for detailed information.

Standard accessories

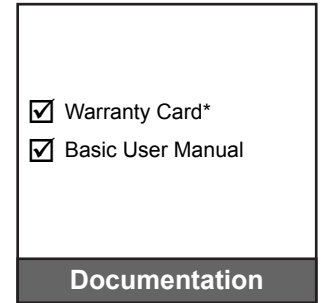
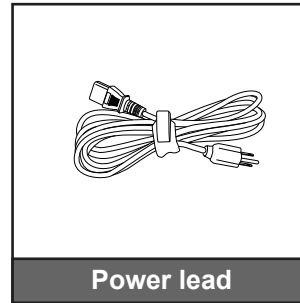
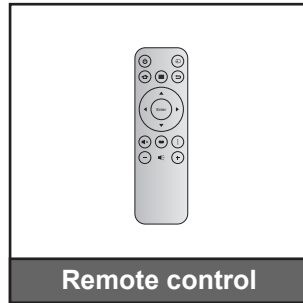
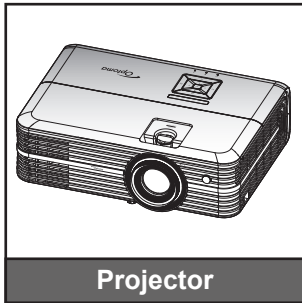

Note:

- The actual remote control may vary depending on the region.
- The remote control is shipped with the battery.
- * For European warranty information, please visit www.optoma.com.

Optional accessories

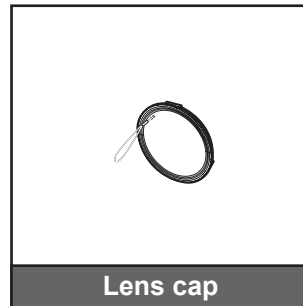
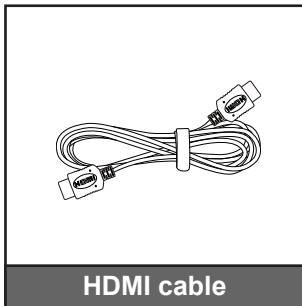

Note: Optional accessories vary depending on model, specification and region.

INTRODUCTION

Product Overview

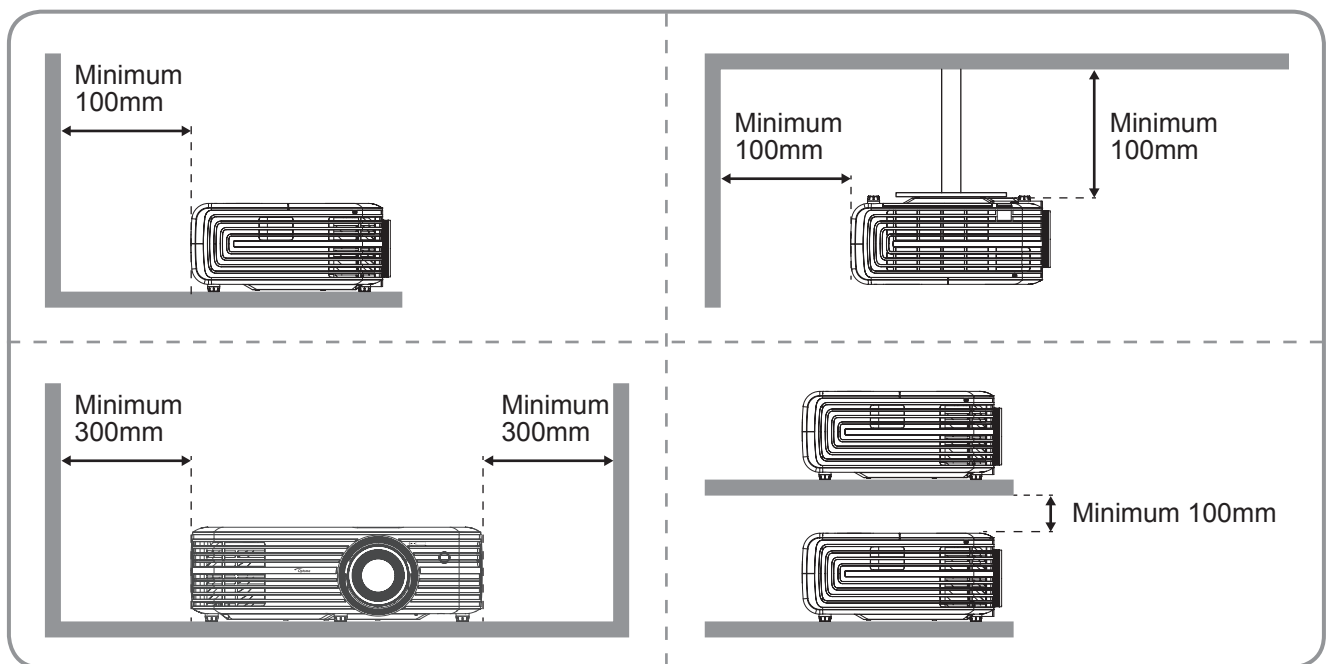
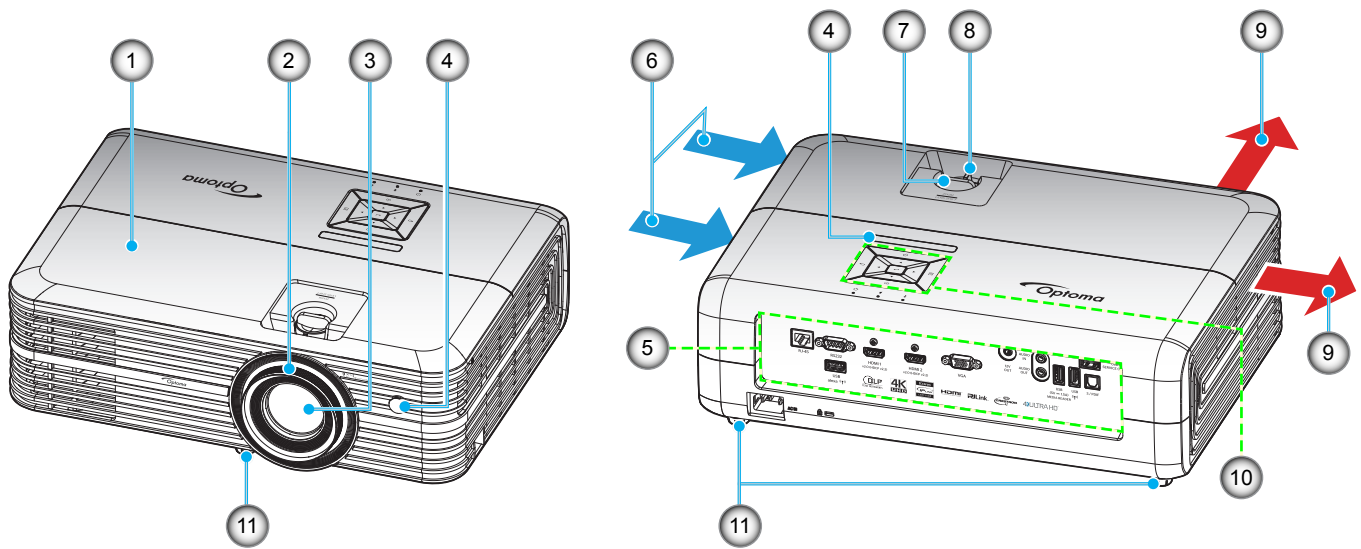

Note:

- Do not block projector intake and exhaust vents.
- When operating the projector in an enclosed space, allow at least 30 cm clearance around the intake and exhaust vents.

No	Item	No	Item
1.	Top Cover	7.	Lens Shift Dial
2.	Focus Ring	8.	Zoom Lever
3.	Lens	9.	Ventilation (outlet)
4.	IR Receiver	10.	Keypad
5.	Input / Output	11.	Tilt-Adjustment Foot
6.	Ventilation (inlet)		

INTRODUCTION

Connections

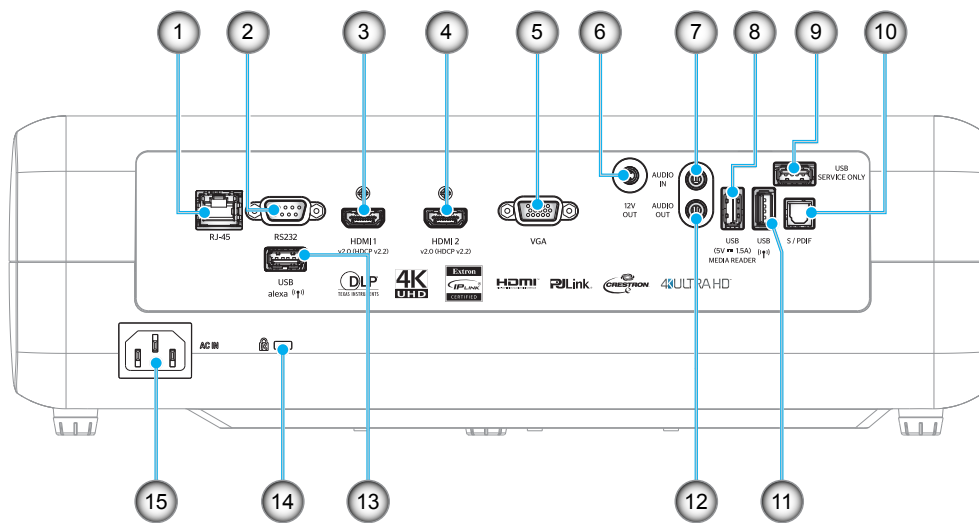

No	Item	No	Item
1.	RJ-45 Connector	9.	Service Connector
2.	RS232 Connector	10.	S/PDIF Connector
3.	HDMI 1 Connector	11.	USB2.0 Connector
4.	HDMI 2 Connector	12.	AUDIO OUT Connector
5.	VGA Connector	13.	USB-A Connector
6.	12V OUT Connector	14.	Kensington™ Lock Port
7.	AUDIO IN Connector	15.	Power Socket
8.	USB Power Out (5V/1.5A) / USB3.0 Connector		

INTRODUCTION

Keypad

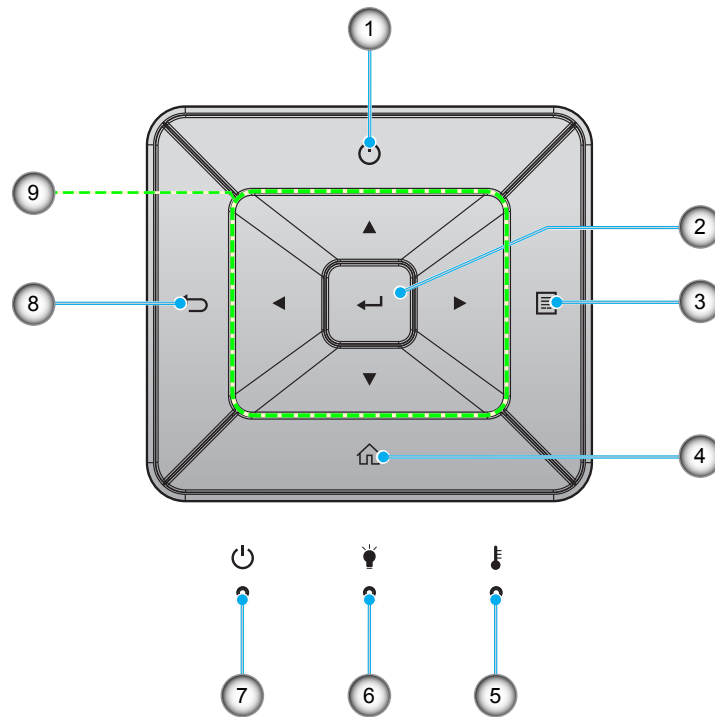

No	Item	No	Item
1.	Power	6.	Lamp LED
2.	Enter	7.	On/Standby LED
3.	Menu	8.	Return
4.	Home	9.	Four Directional Select Keys
5.	Temp LED		

INTRODUCTION

Remote control

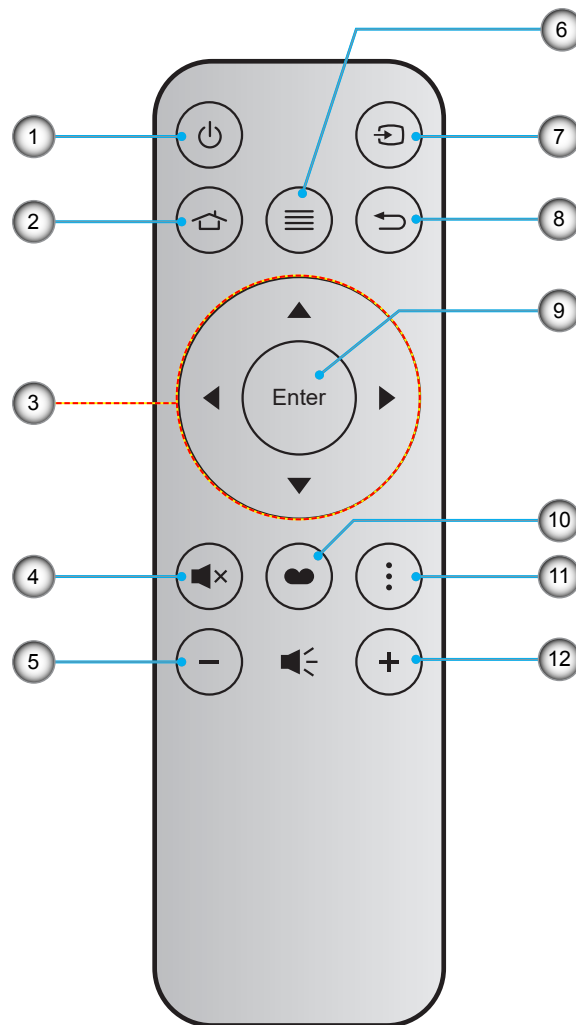

No	Item	No	Item
1.	Power On / Off	7.	Source
2.	Home	8.	Return
3.	Four Directional Select Keys	9.	Enter
4.	Mute	10.	Display Mode
5.	Volume -	11.	Option
6.	Menu	12.	Volume +

Note:

- Some keys may have no function for models that do not support these features.
- Before using the remote control for the first time, remove the transparent insulation tape. See page 16 for battery installation.

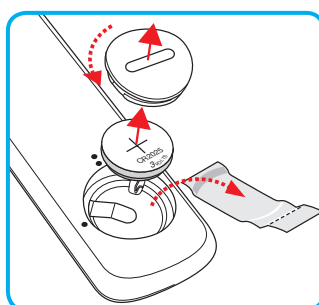

SETUP AND INSTALLATION

Installing the projector

Your projector is designed to be installed in one of four possible positions.

Your room layout or personal preference will dictate which installation location you select. Take into consideration the size and position of your screen, the location of a suitable power outlet, as well as the location and distance between the projector and the rest of your equipment.

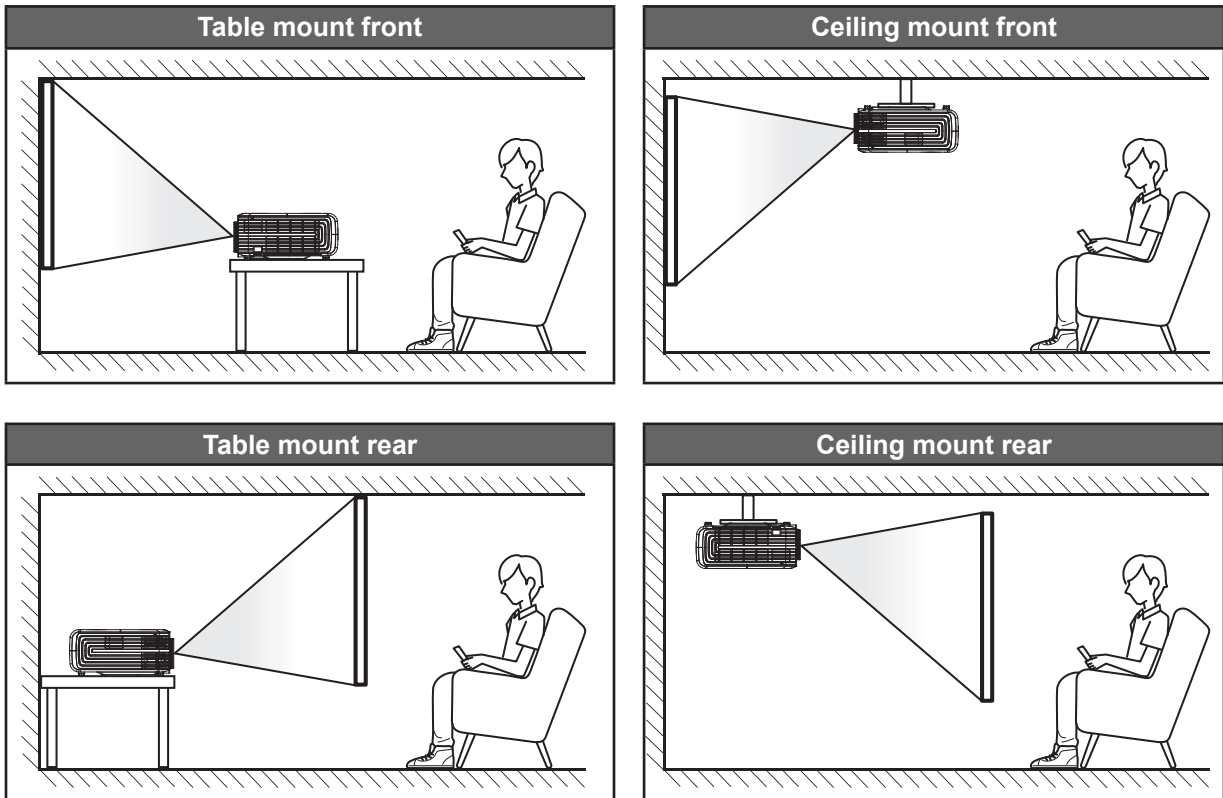

Projector should be placed flat on a surface and 90 degrees / perpendicular to the screen.

- How to determine projector location for a given screen size, please refer to distance table on page 57.
- How to determine screen size for a given distance, please refer to distance table on page 57.

Note: *The further away the projector is placed from the screen the projected image size increases and vertical offset also increases proportionally.*

IMPORTANT!

Do not operate the projector in any orientation other than table top or ceiling mount. The projector should be horizontal and not tilted either forwards/backwards or left/right. Any other orientation will invalidate the warranty and may shorten the lifetime of the projector lamp or the projector itself. For non standard installation advise please contact Optoma.

SETUP AND INSTALLATION

Connecting sources to the projector

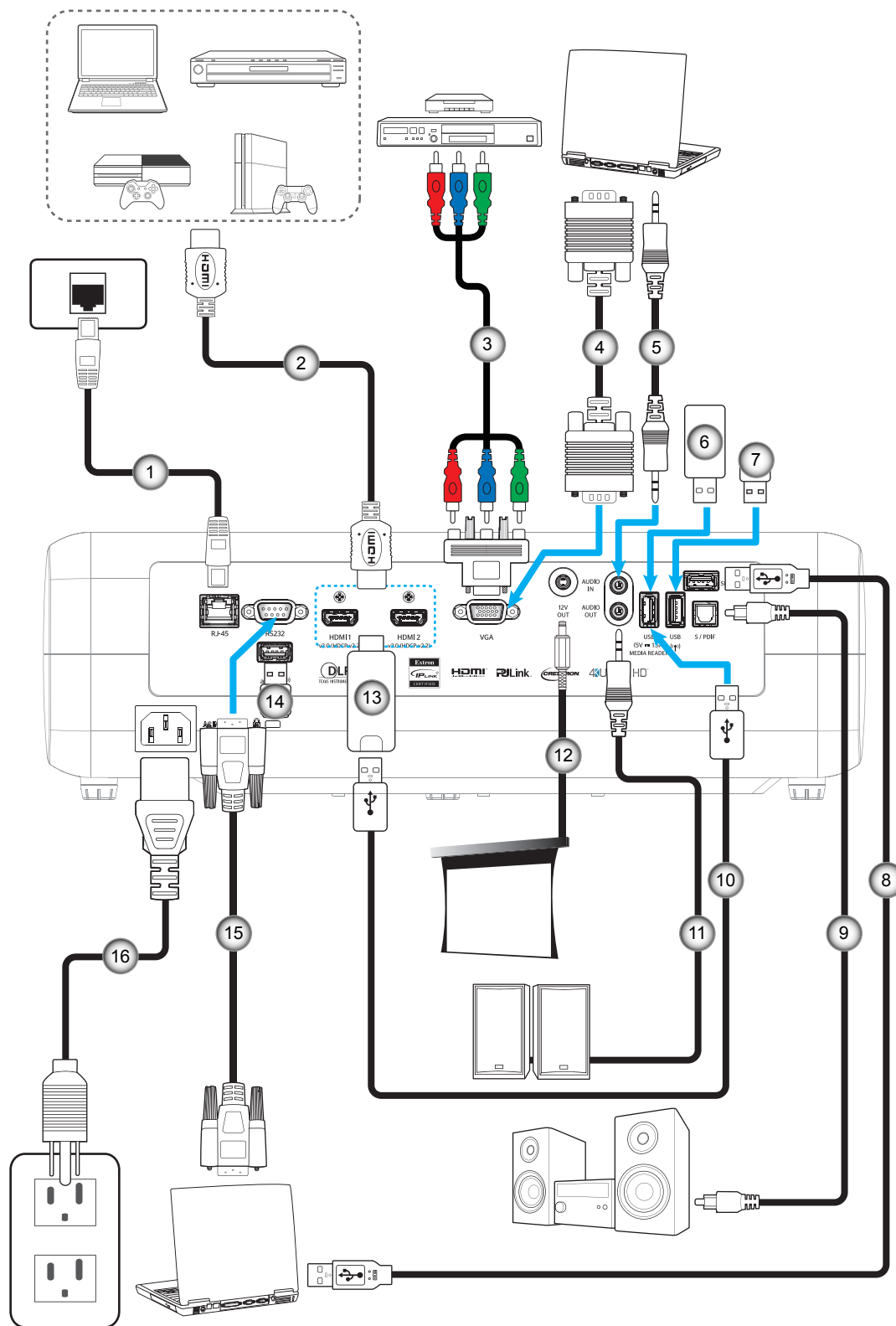

No	Item	No	Item	No	Item	No	Item
1.	RJ-45 Cable	5.	Audio In Cable	9.	S/DPDIF Out Cable	13.	HDMI Dongle
2.	HDMI Cable	6.	USB Flash Drive	10.	USB Power Cable	14.	Wi-Fi Dongle for Alexa
3.	RCA Component Cable	7.	Wi-Fi Dongle for Wi-Fi Display	11.	Audio Out Cable	15.	RS232 Cable
4.	VGA In Cable	8.	USB Cable for Service	12.	12V DC Jack	16.	Power Cord

SETUP AND INSTALLATION

Adjusting the projector image

Image height

The projector is equipped with elevator feet for adjusting the image height.

1. Locate the adjustable foot you wish to adjust on the underside of the projector.
2. Rotate the adjustable foot clockwise or counterclockwise to raise or lower the projector.

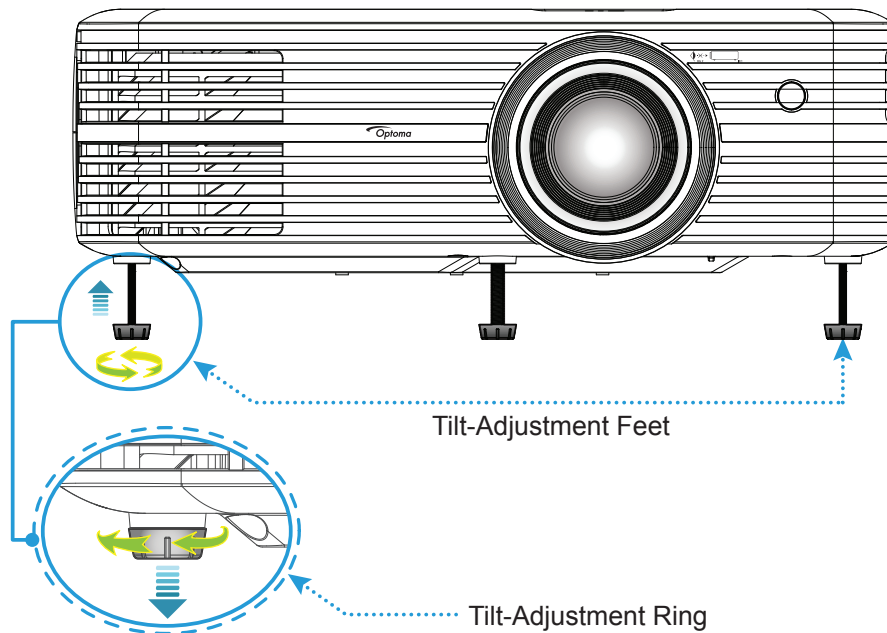

Zoom, lens shift, and focus

- To adjust the image size and position, do the following:
 - a. To adjust the image size, turn the zoom lever clockwise or counterclockwise to increase or decrease the projected image size.
 - b. To adjust the image position, turn the lens shift dial clockwise or counterclockwise to adjust the position of the projected image vertically.

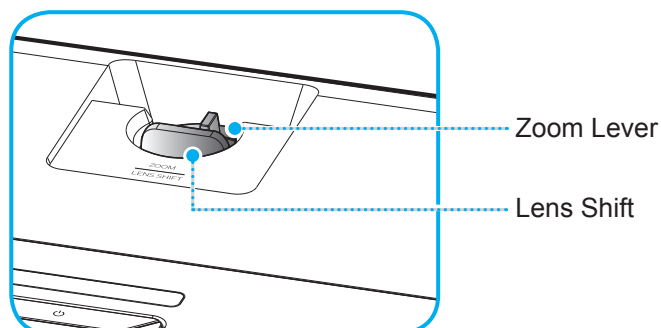

SETUP AND INSTALLATION

- To adjust the focus, turn the focus ring clockwise or counterclockwise until the image is sharp and legible.

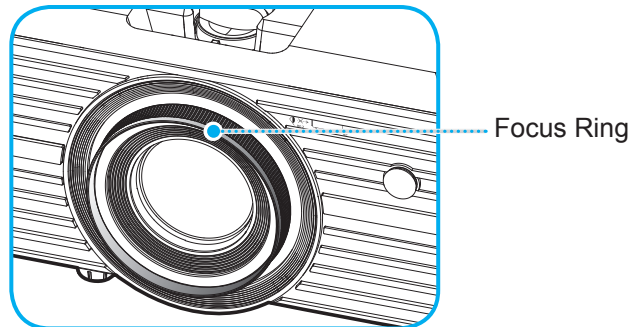

Note: The projector will focus at a distance of 1.2m to 8.1m.

Remote setup

Installing / replacing the battery

1. Use a coin to turn the battery cover counterclockwise until the cover opens.
2. Install new battery into the compartment.
Remove the old battery and install new one (CR2025). Ensure that the side with a "+" is facing up.
3. Put the cover back. Then use a coin to turn the battery cover clockwise to lock it in place.

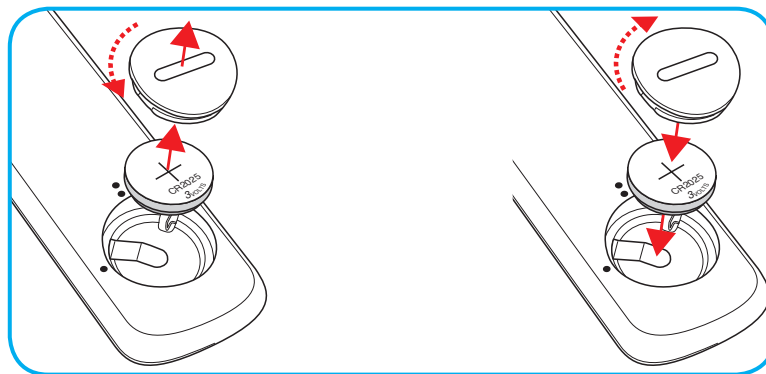

CAUTION:

To ensure safe operation, please observe the following precautions:

- Use CR2025 type battery.
- Avoid contact with water or liquid.
- Do not expose the remote control to moisture or heat.
- Do not drop the remote control.
- If the battery has leaked in the remote control, carefully wipe the case clean and install new battery.
- Risk of an explosion if battery is replaced by an incorrect type.
- Dispose of used battery according to the instructions.

SETUP AND INSTALLATION

Effective range

Infra-Red (IR) remote control sensor is located on top of the projector. Ensure to hold the remote control at an angle within 30° (horizontally) or 20° (vertically) perpendicular to the projector's IR remote control sensor to function correctly. The distance between the remote control and the sensor should not be longer than 7 meters (~22 feet).

Note: When pointing the remote control directly (0 degrees angle) on the IR sensor, the distance between the remote control and the sensor should not be longer than 10 meters (~32 feet).

- Make sure that there are no obstacles between the remote control and the IR sensor on the projector that might obstruct the infra-red beam.
- Make sure the IR transmitter of the remote control is not being shined by sunlight or fluorescent lamps directly.
- Please keep the remote controller away from fluorescent lamps for over 2 meters or the remote controller might become malfunction.
- If the remote control is close to Inverter-Type fluorescent lamps, it might become ineffective from time to time.
- If the remote control and the projector are within a very short distance, the remote control might become ineffective.
- When you aim at the screen, the effective distance is less than 7 meters from the remote control to the screen and reflecting the IR beams back to the projector. However, the effective range might change according to screens.

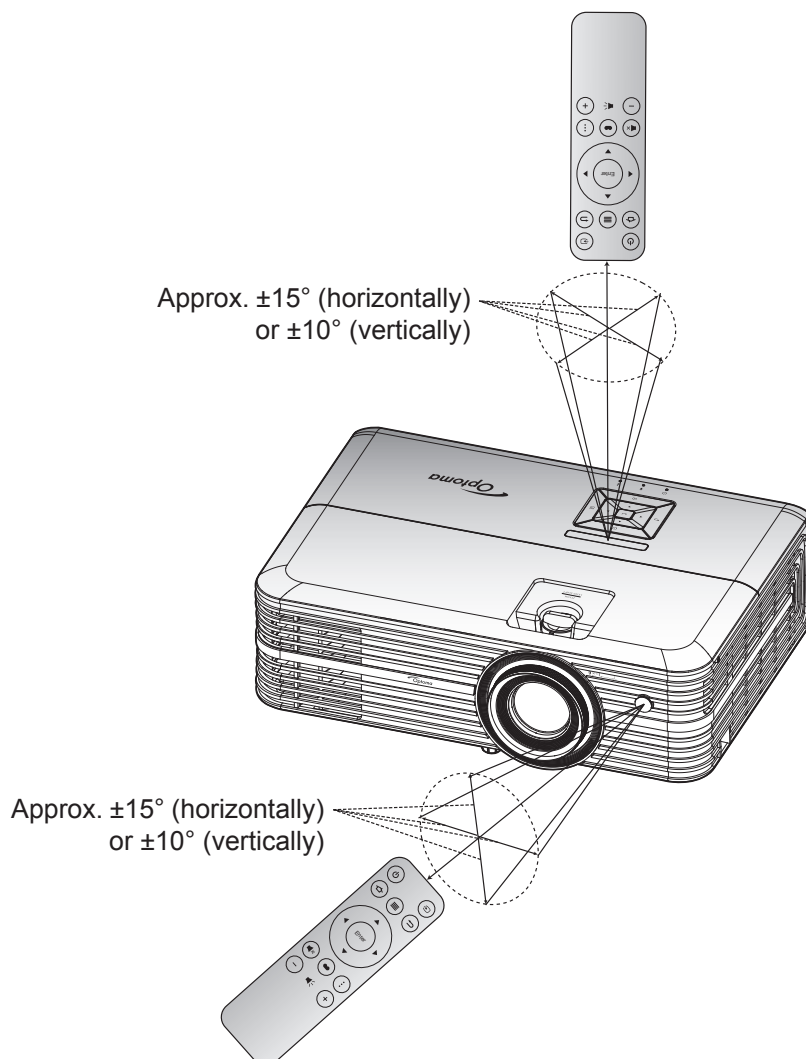

USING THE PROJECTOR

Powering on / off the projector

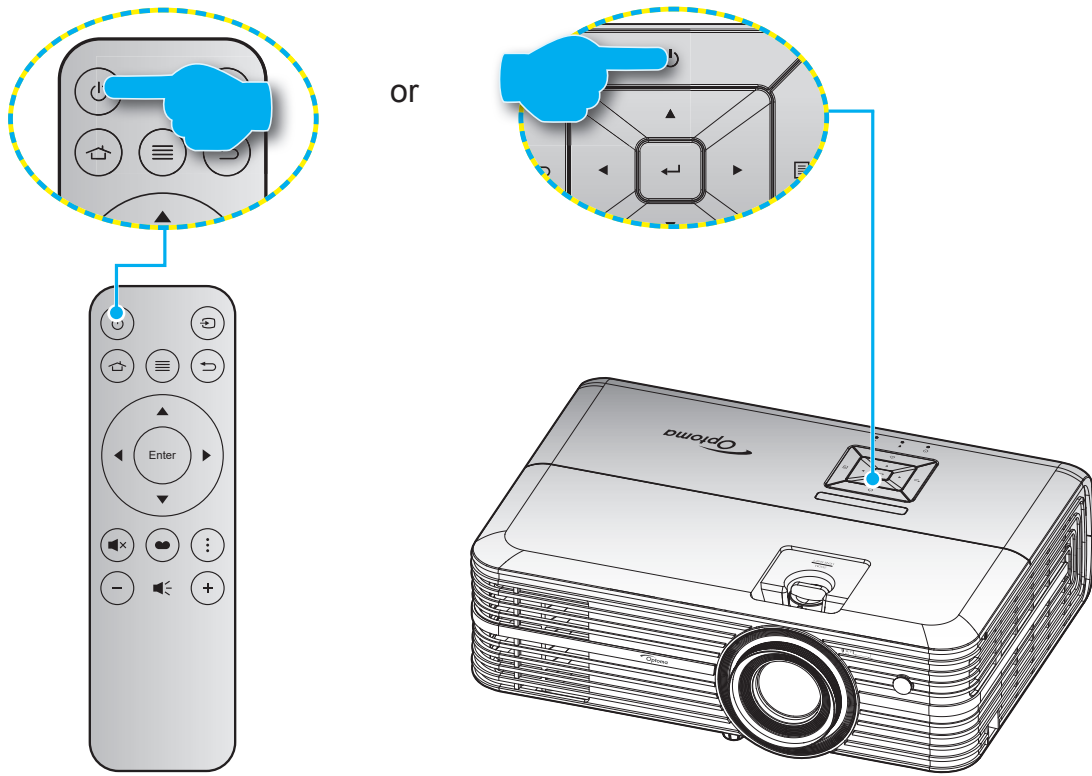

Powering on

1. Securely connect the power lead and signal/source cable. When connected, the On/Standby LED will turn red.
2. Turn on the projector by pressing the “” button on the projector keypad or the remote control.
3. A start up screen will display in approximately 10 seconds and the On/Standby LED will be flashing blue.

The first time the projector is turned on, you will be prompted to do the initial setup including selecting the preferred language, projection orientation, and power mode settings. Once the **Complete set** screen appears, this indicates the projector is ready to use.

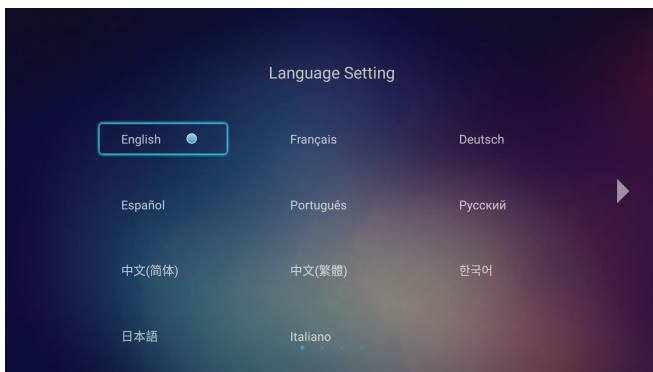

[Select Language]

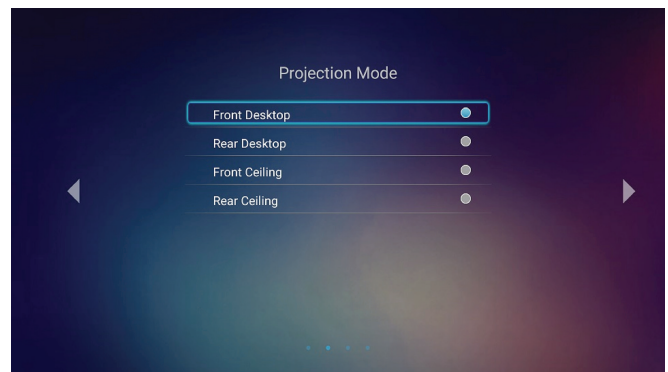

[Select Projection Mode]

USING THE PROJECTOR



[Select Power Mode]

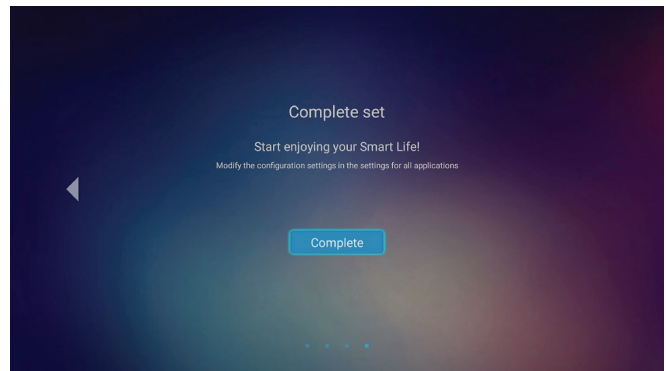

[Initial Setup Complete]

Powering off

1. Turn off the projector by pressing the “⏻” button on the projector keypad or the remote control.
2. The following message will be displayed:



3. Press the “⏻” button again to confirm, otherwise the message will disappear after 15 seconds. When you press the “⏻” button for the second time, the projector will shut down.
4. The cooling fans will continue to operate for about 10 seconds for the cooling cycle and the On/Standby LED will flash green or flash blue. When the On/Standby LED turns solid red, this indicates the projector has entered standby mode. If you wish to turn the projector back on, you must wait until the cooling cycle has finished and the projector has entered standby mode. When the projector is in standby mode, simply press the “⏻” button again to turn on the projector.
5. Disconnect the power lead from the electrical outlet and the projector.

Note: *It is not recommended that the projector is turned on immediately, right after a power off procedure.*

USING THE PROJECTOR

Selecting an input source

Turn on the connected source that you want to display on the screen, such as computer, notebook, video player, etc. The projector will automatically detect the source. If multiple sources are connected, press the “↻” button on the remote control to select the desired input.

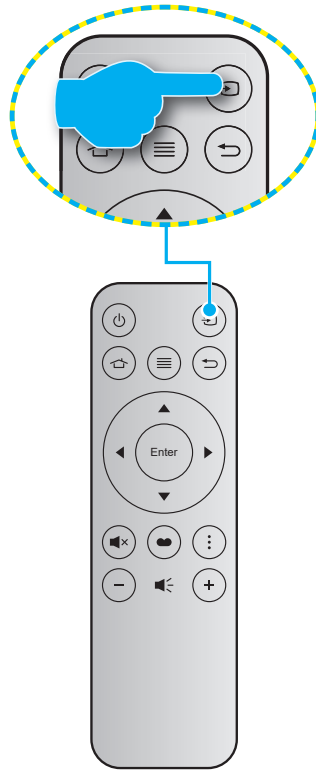



USING THE PROJECTOR

Home screen overview

The Home screen is displayed every time you start the projector. From the main Home screen, it basically divided into 3 main categories: Projector, Application, and Settings.

To navigate the Home screen, simply use the buttons on the remote control or the projector keypad.

You can return to the main Home screen at any time by pressing the  on the remote control or  on the projector keypad, regardless of what page you are on.

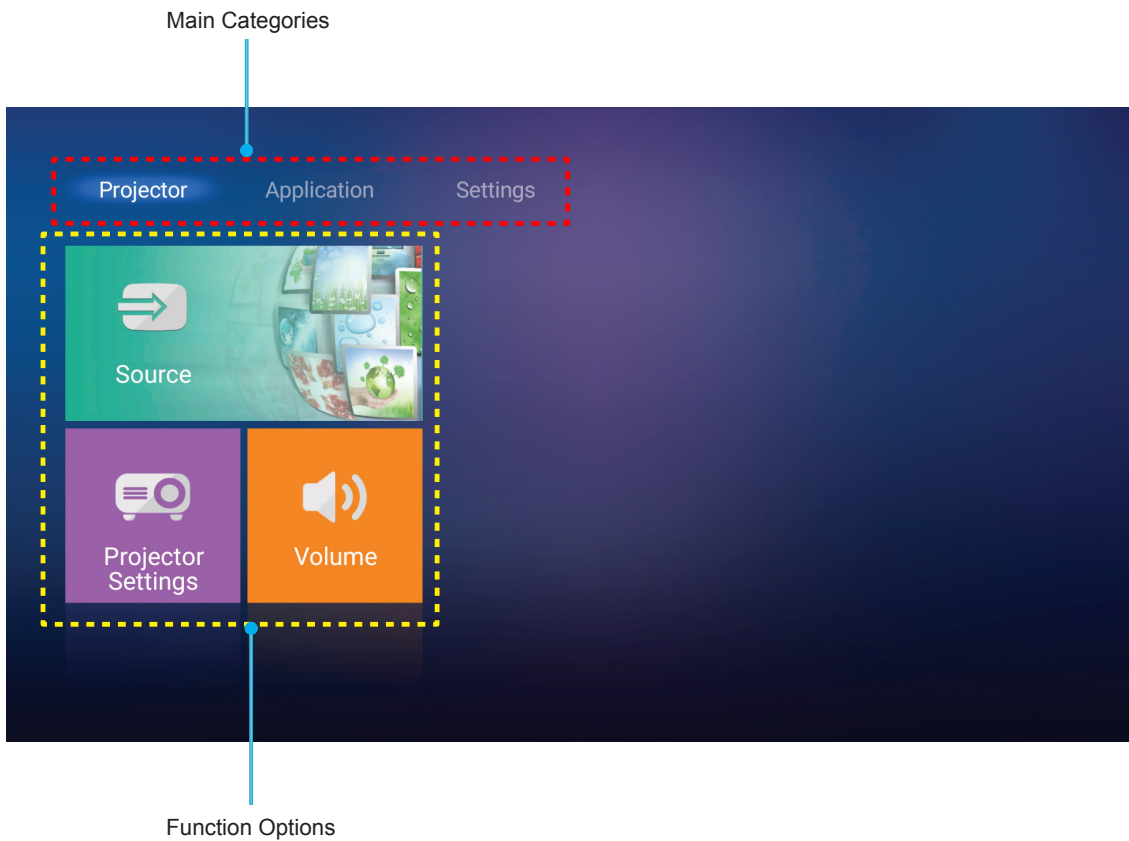

USING THE PROJECTOR

Projector settings

On the **Projector** home screen, you can change the input source, configure the projector settings, and adjust the volume level.

Selecting an input source

Besides pressing the “↩” button on the remote control to select the desired input, you can also change the input source by selecting **Source** option. Then press **Enter** on the remote control or **↵** on the projector keypad to enter the **Source** menu.

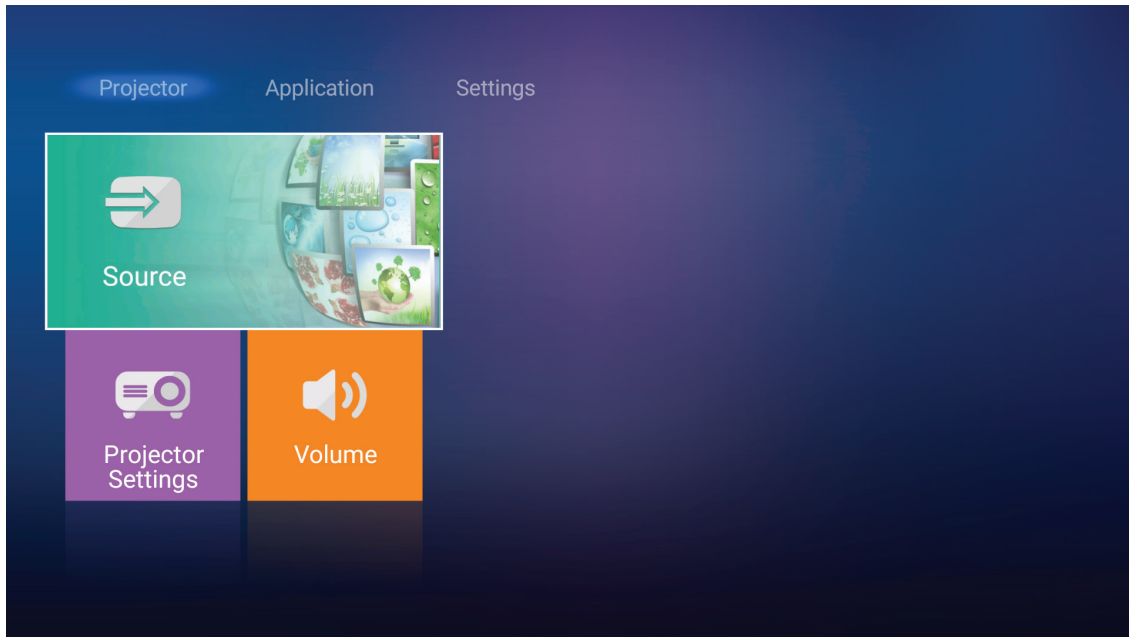

The available input source options appear on the screen.

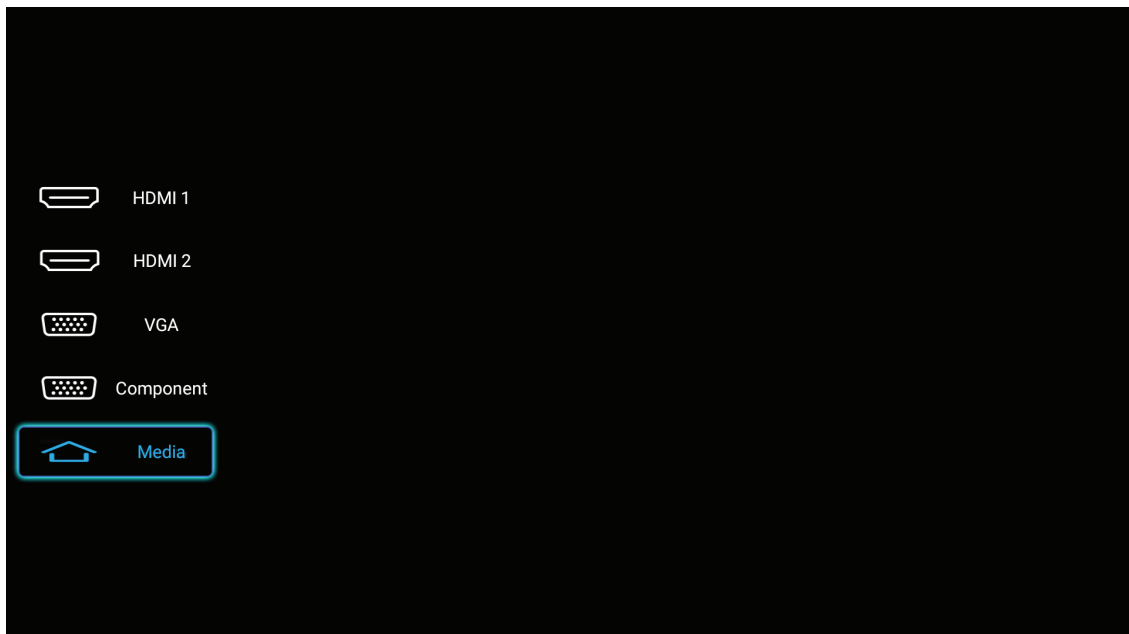

Select the desired input source and press **Enter** on the remote control or **↵** on the projector keypad to confirm the selection.

Note: By default, the input source is set to **Media**.

USING THE PROJECTOR

Configure the projector settings

Select **Projector Settings** to manage various device configurations including configuring the device settings, viewing the system information, and restore the system settings.

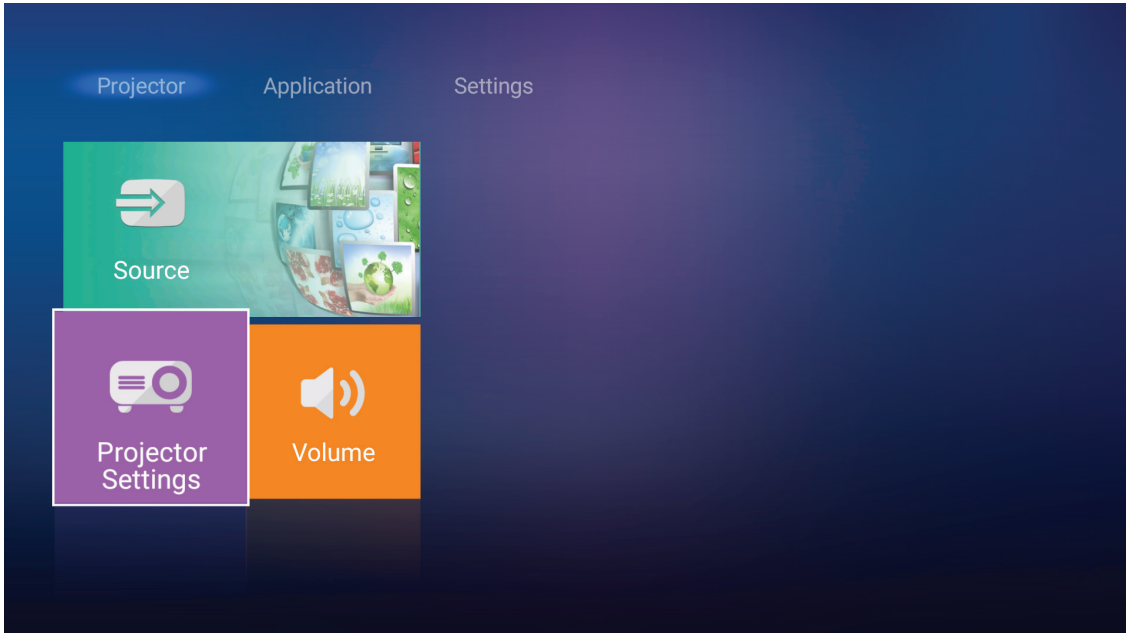

General menu navigation

1. Press **Enter** on the remote control or **↵** on the projector keypad to enter the **Projector Settings** menu.

Note: You can also directly access the **Projector Settings** menu by pressing **≡** on the remote control or **≡** on the projector keypad.

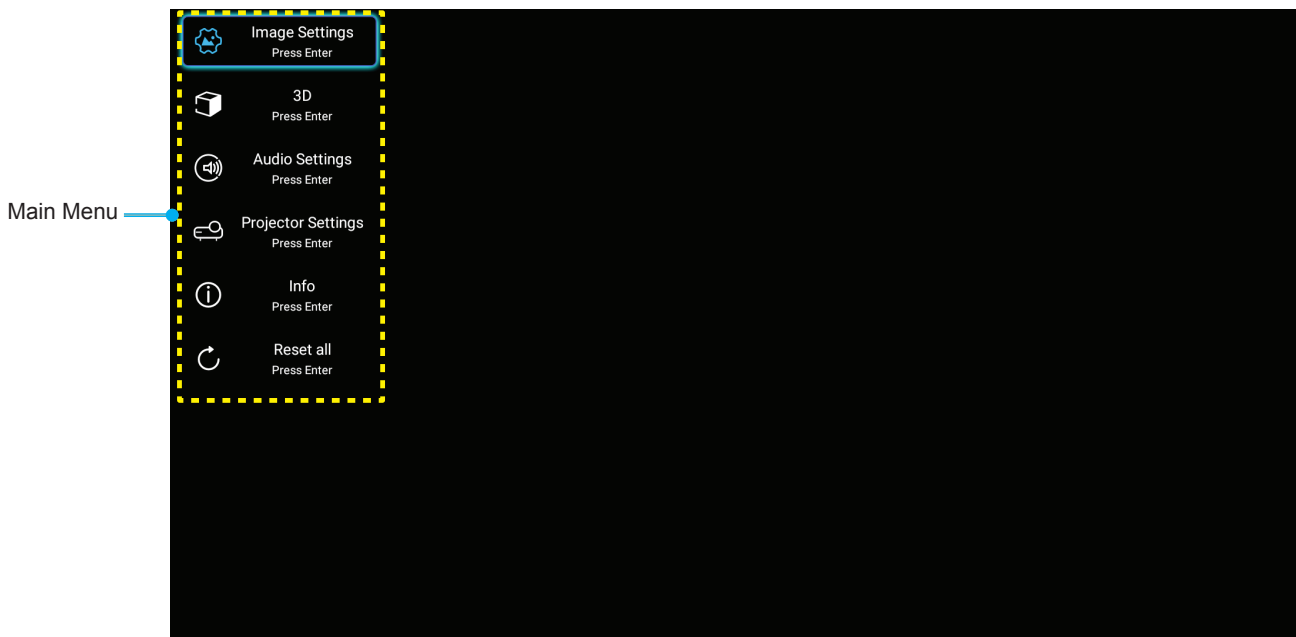

2. When OSD is displayed, use **▲▼** keys to select any item in the main menu. While making a selection on a particular page, press **Enter** on the remote control or **↵** on the projector keypad to enter submenu.

USING THE PROJECTOR

3. Use ▲▼ keys to select the desired item in the sub menu and then press **Enter** or **↵** to view further settings. Adjust the settings by using ◀▶ keys.
4. Select the next item to be adjusted in the sub menu and adjust as described above.
5. Press **Enter** or **↵** to confirm, and the screen will return to the main menu.
6. To exit, press ☰ or ☲ again. The OSD menu will close and the projector will automatically save the new settings.

OSD Menu tree

Level 1	Level 2	Level 3	Level 4	Value	
Image Settings	Display Mode			Cinema	
				HDR	
				HDR SIM.	
				Game	
				Reference	
				Bright	
				User	
				3D	
				ISF Day	
				ISF Night	
	Dynamic Range	HDR			Auto [Default]
					Off
		HDR Picture Mode			Bright
					Standard [Default]
					Film
					Detail
	Brightness			-50 ~ +50	
	Contrast			-50 ~ +50	
	Sharpness			1 ~ 15	
	Color			-50 ~ +50	
	Tint			-50 ~ +50	
	Gamma [Not 3D Mode]				Film
					Video
					Graphics
					Standard(2.2)
					1.8
					2.0
	Gamma [3D Mode]				2.4
					3D
		Color Settings	BrilliantColor™		
	Color Temperature				
					D65
					D75
				D83	
				D93	
				Native	





USING THE PROJECTOR

Level 1	Level 2	Level 3	Level 4	Value	
Image Settings	Color Settings	Color Gamut		Native	
				HDTV	
				Presentation	
				Cinema	
				Game	
		Color Space [Not HDMI Input]		Auto [Default]	
				RGB	
				YUV	
		Color Space [HDMI Input]		Auto [Default]	
				RGB(0~255)	
				RGB(16~235)	
				YUV	
		Color Matching	Color		Red [Default]
					Green
					Blue
					Cyan
					Yellow
					Magenta
					White
			Hue or Red Gain	-50 ~ +50 [Default:0]	
			Saturation or Green Gain	-50 ~ +50 [Default:0]	
			Gain or Blue Gain	-50 ~ +50 [Default:0]	
		RGB Gain / Bias		Red Gain	-50 ~ +50 [Default:0]
				Green Gain	-50 ~ +50 [Default:0]
				Blue Gain	-50 ~ +50 [Default:0]
				Red Bias	-50 ~ +50 [Default:0]
				Green Bias	-50 ~ +50 [Default:0]
				Blue Bias	-50 ~ +50 [Default:0]
		Signal	Frequency		-50 ~ +50 (depends on signal)
			Phase		0 ~ 31 (depends on signal)
	H. Position			-50 ~ +50 (depends on signal)	
	V. Position			-50 ~ +50 (depends on signal)	
	Dynamic Black			On [Default]	
				Off	
	Brightness Mode			Eco.	
				Bright	
	Digital Zoom			-5 ~ 25 [Default:0]	
	Aspect Ratio			4:3	
				16:9	
				Native	
			Auto [Default]		

USING THE PROJECTOR

Level 1	Level 2	Level 3	Level 4	Value
Image Settings	PureMotion			Off
				Low
				Middle
				High
	Reset			
3D	3D Mode			On
				Off [Default]
	3D Format			Auto [Default]
				SBS
				Top and Bottom
				Frame Packing
	3D Sync Invert			On
			Off [Default]	
Audio Settings	Internal Speaker			On [Default]
				Off
	Audio Out			On
				Off [Default]
	Mute			On
				Off [Default]
	Volume			0 ~ 10 [Default:5]
Projector Settings	Lamp Settings	Lamp Hour		Read-Only [Range 0 ~ 9999]
		Lamp Reset		Yes
				No [Default]
		Lamp Reminder		On [Default]
				Off
		Filter Settings	Filter Usage Hour	
	Filter Reminder			Off [Default]
				300hr
				500hr
				800hr
	Filter Reset			1000hr
				Yes
			No [Default]	
	Power Settings	Direct Power On		On
				Off [Default]
		Auto Power Off		On [Default]
				Off
Sleep Timer(min.)			Off(0) ~ 990 (30 min increments) [Default: Off]	
Power Mode(Standby)			Eco. [Default]	
			Active	
		Full Power Active		

USING THE PROJECTOR

Level 1	Level 2	Level 3	Level 4	Value	
Projector Settings	Others	Projector ID		0 ~ 99 [Default: 0]	
		Test Pattern		None [Default]	
				Grid (Green)	
				Grid (Magenta)	
				Grid (White)	
				White	
		Projection Mode		Front  [Default]	
				Rear 	
				Front-Ceiling 	
				Rear-Ceiling 	
		HDMI EDID		2.0 [Default]	
				1.4	
		HDMI/VGA/USB Disk		Notification	
				Source Auto-change [Default]	
	None				
High Altitude		On			
		Off [Default]			
12V Trigger		On			
		Off [Default]			
Info	Regulatory				
	Serial Number				
	Source			HDMI1 / HDMI2 / VGA / Component / Media	
	Resolution				
	Display Mode			None / Cinema / HDR / HDR SIM. / Game / Reference / Bright / User / 3D / ISF Day / ISF Night	
	Brightness Mode				
	Power Mode(Standby)			Eco. / Active / Full Power Active	
	Lamp Hour	Bright			"0 hr" ~ "99999 hr"
		Eco.			"0 hr" ~ "99999 hr"
		Dynamic			"0 hr" ~ "99999 hr"
		Total			"0 hr" ~ "299997 hr"
	Filter Usage Hour				"0 hr" ~ "99999 hr"
Projector ID				0 ~ 99	
Color Depth					
Color Format					
Info	FW Version	System			
		LAN			
		MCU			
Reset All					

USING THE PROJECTOR

Image settings menu

Display mode

There are many factory presets optimized for various types of images.

- **Cinema:** Provides the best colors for watching movies.
- **HDR:** Decodes and displays High Dynamic Range (HDR) content for the deepest blacks, brightest whites, and vivid cinematic color using REC.2020 color gamut. This mode will be automatically enabled if HDR is set to ON (and HDR Content is sent to projector – 4K UHD Blu-ray, 1080p/4K UHD HDR Games, 4K UHD Streaming Video). While HDR mode is active, other display modes (Cinema, Reference, etc.) cannot be selected as HDR delivers color that is highly accurate, exceeding the color performance of the other display modes.
- **HDR SIM.:** Enhances non-HDR content with simulated High Dynamic Range (HDR). Choose this mode to enhance gamma, contrast, and color saturation for non-HDR content (720p and 1080p Broadcast/Cable TV, 1080p Blu-ray, non-HDR Games, etc). This mode can ONLY be used with non-HDR content.
- **Game:** Select this mode to increase the brightness and response time level for enjoying video games.
- **Reference:** This mode is intended to reproduce as close as possible the image the way the movie director intended. Color, color temperature, brightness, contrast and gamma settings are all configured to standard reference levels. Select this mode to watch a video.
- **Bright:** Maximum brightness from PC input.
- **User:** Memorize user's settings.
- **3D:** To experience the 3D effect, you need to have 3D glasses. Make sure a Blu-ray 3D DVD player is installed.
- **ISF Day:** Optimize the image with the ISF Day mode to be perfectly calibrated and high picture quality.
- **ISF Night:** Optimize the image with the ISF Night mode to be perfectly calibrated and high picture quality.

Note: For access and calibration of ISF daytime and night viewing modes, please contact your local dealer.

Dynamic Range

Configure the High Dynamic Range (HDR) setting and its effect when displaying video from 4K Blu-ray players and streaming devices.

➤ HDR

- **Auto:** Auto detect HDR signal.
- **Off:** Turn off HDR Processing. When set to Off, the projector will NOT decode HDR content.

➤ HDR Picture Mode

- **Bright:** Choose this mode for brighter more saturated colors.
- **Standard:** Choose this mode for natural looking colors with a balance of warm and cool tones.
- **Film:** Choose this mode for improved detail and image sharpness.
- **Detail:** Choose this mode for improved detail and image sharpness in dark scenes.

Brightness

Adjust the brightness of the image.

Contrast

The contrast controls the degree of difference between the lightest and darkest parts of the picture.

Sharpness

Adjust the sharpness of the image.

USING THE PROJECTOR

Color

Adjust a video image from black and white to fully saturated color.

Tint

Adjust the color balance of red and green.

Gamma

Set up gamma curve type. After the initial setup and fine tuning is completed, utilize the Gamma Adjustment steps to optimize your image output.

- **Film:** For home theater.
- **Video:** For video or TV source.
- **Graphics:** For PC / Photo source.
- **Standard(2.2):** For standardized setting.
- **1.8 / 2.0 / 2.4:** For specific PC / Photo source.

Note: *These options are only available if the 3D mode function is disabled. In 3D mode, user can only select 3D for Gamma setting.*

Color Settings

Configure the color settings.

- **BrilliantColor™:** This adjustable item utilizes a new color-processing algorithm and enhancements to enable higher brightness while providing true, more vibrant colors in picture.
- **Color Temperature:** Select a color temperature from D55, D65, D75, D83, D93, or Native.
- **Color Gamut:** Select an appropriate color gamut from Native, HDTV, Presentation, Cinema, or Game.
- **Color Space (non-HDMI input only):** The Color Space is fixed in the following input sources: (1) VGA(RGB) (2) Component(YUV) (3) Media(Auto).
- **Color Space (HDMI input only):** select an appropriate color matrix type from the following: Auto, RGB(0-255), RGB(16-235), YUV(0-255), and YUV(16-235).
- **Color Matching:** Adjust hue, saturation, and gain for the red, green, blue, cyan, yellow, magenta, or white color.
- **RGB Gain/Bias:** This settings allows to configure the brightness (gain) and contrast (bias) of an image.

Signal

Adjust the signal options.

- **Frequency:** Change the display data frequency to match the frequency of your computer's graphic card. Use this function only if the image appears to flicker vertically.
- **Phase:** Synchronize the signal timing of the display with the graphic card. If the image appears to be unstable or flickers, use this function to correct it.
- **H. Position:** Adjust the horizontal positioning of the image.
- **V. Position:** Adjust the vertical positioning of the image.

Note: *This menu is only available if the input source is RGB.*

Dynamic Black

Use to automatically adjust the picture brightness to give optimum contrast performance.

USING THE PROJECTOR

Brightness Mode

Adjust the brightness mode settings.

- **Eco:** Choose “Eco” to dim the projector lamp which will lower power consumption and extend the lamp life.
- **Bright:** Choose “Bright” to increase the brightness.

Digital Zoom

Use to reduce or magnify an image on the projection screen.



Aspect ratio

Select the aspect ratio of the displayed image.

- **4:3:** This format is for 4:3 input sources.
- **16:9:** This format is for 16:9 input sources, like HDTV and DVD enhanced for Wide screen TV.
- **Native:** This format displays the original image without any scaling.
- **Auto:** Automatically selects the appropriate display format.

Note:

- *It is considered normal that black bars appear around the image with a resolution of 4K in each aspect mode.*
- *The black bars and border will change in size depending on the aspect ratio.*

-  Black bars
-  4K active area

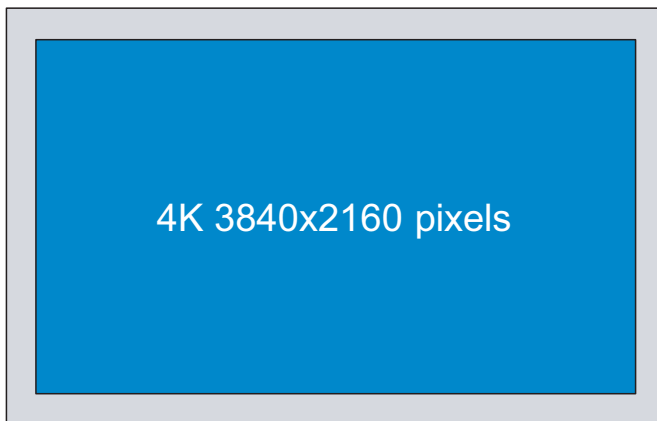

4K UHD scaling table:

16 : 9 screen	480i/p	576i/p	720p	1080i/p	2160p
4x3	Scale to 2880 x 2160.				
16x9	Scale to 3840 x 2160.				
Native mode	1:1 mapping centered. No scaling will be made; the displayed resolution depends on input source.				
Auto	-If source is 4:3, the screen type will be scaled to 2880 x 2160. -If source is 16:9, the screen type will be scaled to 3840 x 2160. -If source is 16:10, the screen type will be scaled to 3456 x 2160.				

USING THE PROJECTOR

Auto mapping rule:

	Input resolution		Auto/Scale	
	H-resolution	V-resolution	3840	2160
4:3	640	480	2880	2160
	800	600	2880	2160
	1024	768	2880	2160
	1280	1024	2880	2160
	1400	1050	2880	2160
	1600	1200	2880	2160
Wide Laptop	1280	720	3840	2160
	1280	768	3600	2160
	1280	800	3456	2160
SDTV	720	576	2700	2160
	720	480	3240	2160
HDTV	1280	720	3840	2160
	1920	1080	3840	2160

PureMotion

Use to preserve a natural motion of the displayed image.

Reset

Return the factory default settings for color settings.

3D menu

Note: The maximum resolution is 1080P (4K resolution is not supported).

3D Mode

Use this option to enable/disable the 3D mode function.

3D Format

Use this option to select the appropriate 3D format content.

- **Auto:** When a 3D identification signal is detected, the 3D format is selected automatically.
- **SBS:** Display 3D signal in “Side-by-Side” format.
- **Top and Bottom:** Display 3D signal in “Top and Bottom” format.
- **Frame Packing:** Display 3D signal in “Frame Packing” format.

3D Sync Invert

Use this option to enable/disable the 3D sync invert function.

USING THE PROJECTOR

Audio settings menu

Internal Speaker

Choose “On” or “Off” to turn on or off the internal speaker.

Audio Out

Choose the “On” or “Off” to turn on or off the audio out.

Mute

Use this option to temporarily turn off the sound.

- **On:** Choose the “On” to turn mute on.
- **Off:** Choose the “Off” to turn mute off.

Note: “Mute” function affects both internal and external speaker volume.

Volume

Adjust the audio volume level.

Projector settings menu

Lamp Settings

- **Lamp Hour:** Display the projection time.
- **Lamp Reset:** Resets the lamp hour counter after replacing the lamp.
- **Lamp Reminder:** Choose this function to show or to hide the warning message when the changing lamp message is displayed. The message will appear 200 hours before suggested replacement of lamp.

Filter Settings

- **Filter Usage Hour:** Display the filter time.
- **Filter Reminder:** Choose this function to show or hide the warning message when the changing filter message is displayed. The available options include 300hr, 500hr, 800hr, and 1000hr.
- **Filter Reset:** Reset the dust filter counter after replacing or cleaning the dust filter.

Power Settings

- **Direct Power On:** Choose “On” to activate Direct Power mode. The projector will automatically power on when AC power is supplied, without pressing the “Power” key on the projector keypad or on the remote control.
- **Auto Power Off:** Choose “On” to activate Auto Power Off mode. When no signal is detected or the projector is left idle for 20 minutes, the projector will automatically power off.
- **Sleep Timer(min.):** Sets the countdown timer interval. The countdown timer will start, with or without a signal being sent to the projector. The projector will automatically power off when the countdown has finished (in minutes).
- **Power Mode(Standby):** Set the power mode setting.
 - **Eco.:** Choose “Eco.” to save power dissipation further < 0.5W.
 - **Active:** Choose “Active” to return to normal standby (LAN on, Wi-Fi off).
 - **Full Power Active:** Choose “Full Power Active” to return to normal standby (LAN on, Wi-Fi on).

Others

- **Projector ID:** ID definition can be set up by menu (range 0-99), and allow user control an individual projector

USING THE PROJECTOR

by using RS232 command.

- **Test Pattern:** Select the test pattern from Grid (Green), Grid (Magenta), Grid (White), White or disable this function (None).
- **Projection Mode:** Select the preferred projection between Front, Rear, Front-Ceiling, and Rear-Ceiling.
- **HDMI EDID:** Select the HDMI EDID type from 2.0 or 1.4.
Note: *If you experience abnormal color issue, please adjust the EDID setting.*
- **HDMI/VGA/USB Disk:** Define how the system will react when one of the input sources (HDMI/VGA/USB flash drive) is connected to the projector.
 - **Notification:** Choose “Notification” to display the input switching confirmation message when an input source is detected.
 - **Source Auto-change:** Choose “Source Auto-change” to automatically switch to the currently detected input source.
 - **None:** Choose “None” to manually switch the input source.
- **High Altitude:** When “On” is selected, the fans will spin faster. This feature is useful in high altitude areas where the air is thin.
- **12V Trigger:** Use this function to enable or disable the trigger.

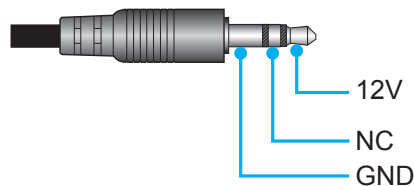

- **On:** Choose “On” to enable the trigger.
- **Off:** Choose “Off” to disable the trigger.

Info menu

View the projector information as listed below:

- Regulatory
- Serial Number
- Source
- Resolution
- Display Mode
- Brightness Mode
- Power Mode(Standby)
- Lamp Hour
- Filter Usage Hour
- Projector ID
- Color Depth
- Color Format
- FW Version

Reset all menu

Return the factory default settings for all settings.

USING THE PROJECTOR

Adjusting the volume level

Select **Volume** to adjust the audio volume level. Then press **Enter** on the remote control or **↵** on the projector keypad to enter the **Volume** menu.

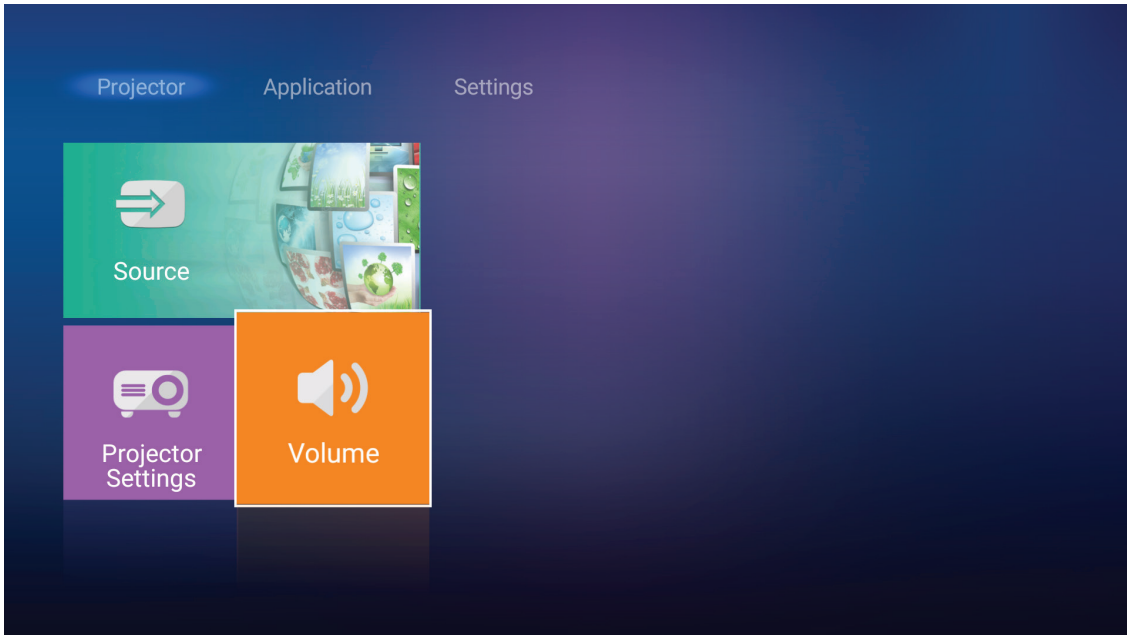

Use **◀▶** keys to adjust the desired volume level.

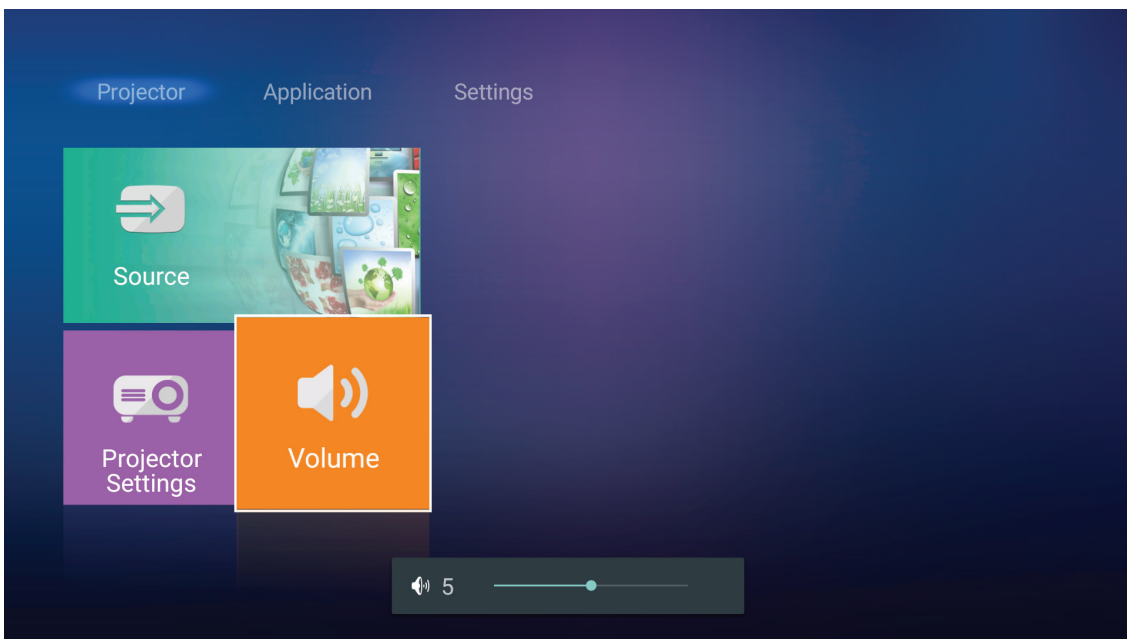

Note: You can set the volume level to 0 to activate the mute function.

USING THE PROJECTOR

Application settings

On the **Application** home screen, you can view the multimedia files, register the projector to the Device Cloud, and stream media files wirelessly. To switch to the **Application** home screen, select one of the main categories and use ◀▶ keys to select **Application**.

Playing multimedia files

Select **Media Player** to browse multimedia files stored in the USB flash drive after connecting to projector.

Note: USB format is only supported on FAT and FAT32.

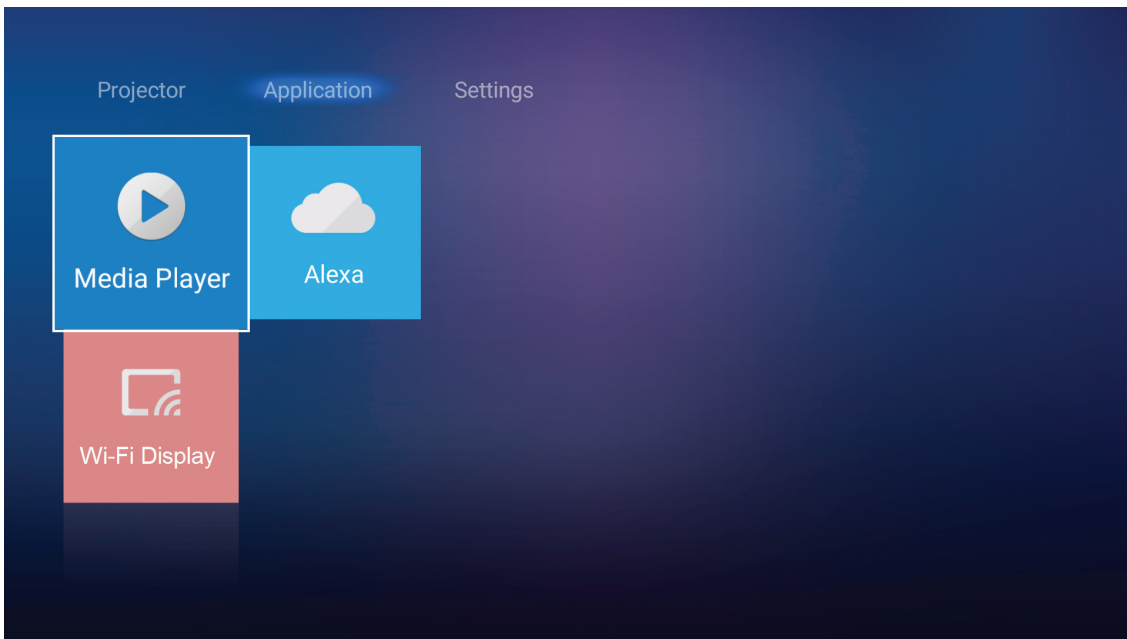

Multimedia support format

Photo

Image Type (Ext name)	Sub Type	Maximum Pixels
Jpeg / Jpg	Baseline	8000 x 8000
	Progressive	6000 x 4000
PNG	Non-interlace	6000 x 4000
	Interlace	6000 x 4000
BMP		6000 x 4000

Audio

Music Type (Ext name)	Sample Rate (KHz)	Bit Rate (Kbps)
MP3	16~48	8~320
WMA	8~48	128~320
ADPCM-WAV	8~48	32~384
PCM-WAV	8~48	64~1536
AAC	8~48	8~48

USING THE PROJECTOR

Video

File Format	Video Format	Decode Maximum Resolution	Maximum Bit Rate (bps)	Profile
MPG, MPEG	MPEG1/2	1920 x 1080 60fps	40M bps	MP@HP
MOV, MP4, MKV	H.264	4096 x 2176 30fps	135M bps	MP/HP @Level 5.1
AVI, MOV, MP4	MPEG4	1920 x 1080 60fps	40M bps	SP/ASP@Level 5.1
AVI, MP4, MOV, MKV	MJPEG	1920 x 1080 30fps	10M bps	Baseline
WMV, ASF	VC-1	1920 x 1080 60fps	40M bps	SP/MP/AP
3GP, MP4, AVI, MOV	H.263	1920 x 1080 60fps	40M bps	
MP4, MOV, MKV	HEVC/H.265	4096 x 2176 60fps	100M bps	Main/Main10 Profile, High Tier @Level 5.1
MKV	VP8	1920 x 1080 60fps	20M bps	
	VP9	4096 x 2176 60fps	100M bps	Profile0,2
MP4, MOV, TS, TRP, TP	AVS	1920 x 1080 60fps	40M bps	Jizhun profile @Level 6.0

Document

Document Format	Support Version and Format	Pages/Lines Limitation	Size Limitation
PDF	PDF 1.0 ~ 1.7 and above	Up to 1500 pages (One File)	Up to 100MB
Word	Kingsoft Writer Document (*.wps)	Since WPS Projector does not load the MS/Word files all at one time, there is no obvious limitation on the number of pages and rows of files.	Up to 150MB
	Kingsoft Writer Template (*.wpt)		
	Microsoft Word 97/2000/XP/2003 Document (*.doc)		
	Microsoft Word 97/2000/XP/2003 Template (*.dot)		
	RTF Files (*.rtf)		
	Text Files (*.txt, *.log, *.lrc, *.c, *.cpp, *.h, *.asm, *.s, *.java, *.asp, *.prg, *.bat, *.bas, *.cmd)		
	Web Page Files (*.html, *.htm)		
	Single Web Page Files (*.mht, *.mhtml)		
	Microsoft Word 2007/2010 Document (*.docx)		
	Microsoft Word 2007/2010 Template (*.dotx)		
	Microsoft Word 2007/2010 Macro-Enabled Document (*.docm)		
	Microsoft Word 2007/2010 Macro-Enabled Template (*.dotm)		
	XML Files (*.xml)		
	OpenDocument Text (*.odt)		
Works 6-9Document (*.wtf)			
Works 6.0&7.0 (*.wps)			

USING THE PROJECTOR

Document Format	Support Version and Format	Pages/Lines Limitation	Size Limitation
Excel	Kingsoft Spreadsheets Files (*.et)	Row Limit: up to 65,535 Column Limit: up to 256 Sheet: up to 200	Up to 30MB
	Kingsoft Spreadsheets Template (*.ett)		
	Microsoft Excel 97/2000/XP/2003 Workbook (*.xls)		
	Microsoft Excel 97/2000/XP/2003 Template (*.xlt)		
	Text Files (*.csv)		
	Web Pages (*.htm, *.html)		
	XML Files (*.xml)		
	Microsoft Excel 2007/2010 Files (*.xlsx, *.xlsm)		
	Microsoft Excel 2007/2010 Template (*.xltx)		
	Microsoft Excel 2007/2010 Binary Workbook (*.xlsb)		
PowerPoint	Kingsoft Presentation Files (*.dps)	Up to 1500 pages (One File)	Up to 30MB
	Kingsoft Presentation Templates (*.dpt)		
	Microsoft PowerPoint 97/2000/XP/2003 Presentations (*.ppt, *.pps)		
	Microsoft PowerPoint 97/2000/XP/2003 Presentation Templates (*.pot)		
	Microsoft PowerPoint 2007/2010 Presentations (*.pptx, *.ppsx)		
Microsoft PowerPoint 2007/2010 Presentations Template (*.potx)			

Note:

- *Decoding may take a while for large files with complex contents.*
- *Objects embedded in files cannot be activated or viewed.*
- *For Microsoft Word*
 - *No support for advanced settings, such as drawing plug-in or table background settings.*
 - *Contents outside the defined borders in Microsoft Word will not be displayed.*
 - *Not support Bold Text in Simplified Chinese font.*
- *For Microsoft PowerPoint*
 - *Slide effects not supported.*
 - *Password-protected sheets are not protected.*
- *For Microsoft Excel*
 - *Worksheets are displayed individually and sequentially when the workbook has multiple worksheets.*
 - *Page layout and numbering may be changed during decoding.*

USING THE PROJECTOR

Entering the multimedia mode

1. Insert a USB flash drive to the USB connector on the rear side of the projector.

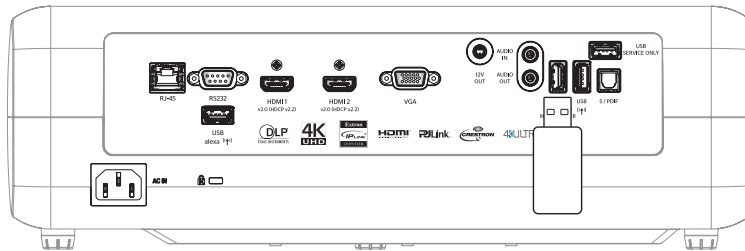

The available files appears on the screen.

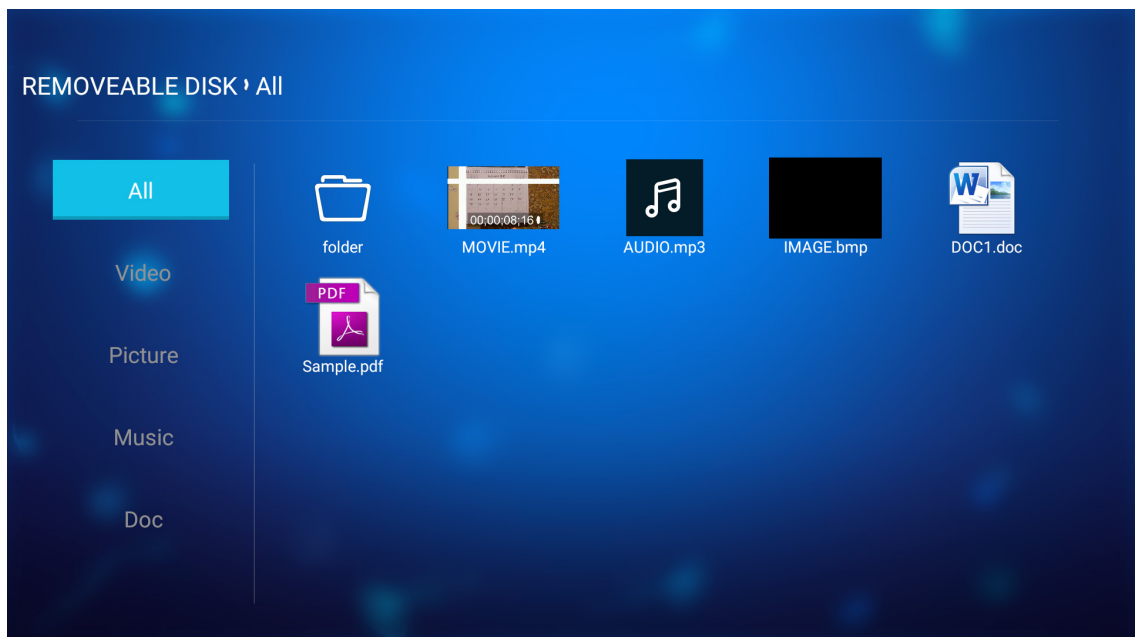

Note: To manually enter the multimedia mode, select **Application > Media Player**.

2. Browse and select the file you want to view.

USING THE PROJECTOR

Playing Videos

1. From the left panel, select **Video** to browse all video files.

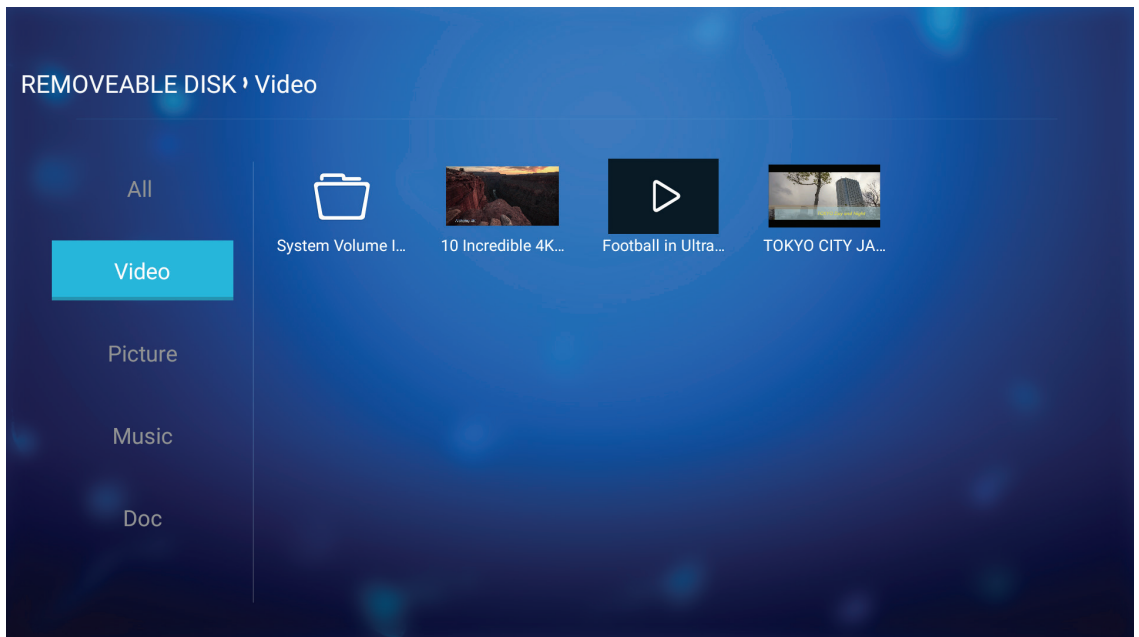

If there are several folders, press **▲▼◀▶** keys to select the desired folder, then press **Enter/↵** to view the subfolder content.

2. Press **▲▼◀▶** keys to select the video you want play, then press **Enter/↵** to start the playback.

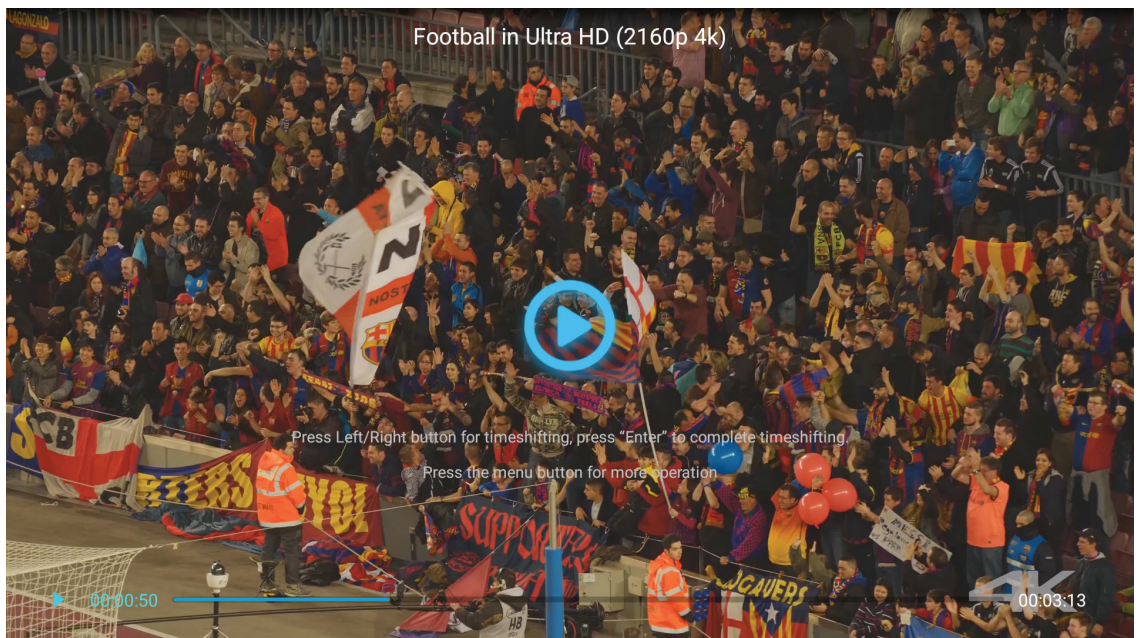

- Press **Enter/↵** to pause the playback. While the video is being paused:
 - Press **◀▶** keys to rewind or fast forward the video.
 - To resume, press **Enter/↵**.
- To stop playback at any time, press **↶**.

USING THE PROJECTOR

Viewing Photos

1. From the left panel, select **Picture** to browse all picture files.

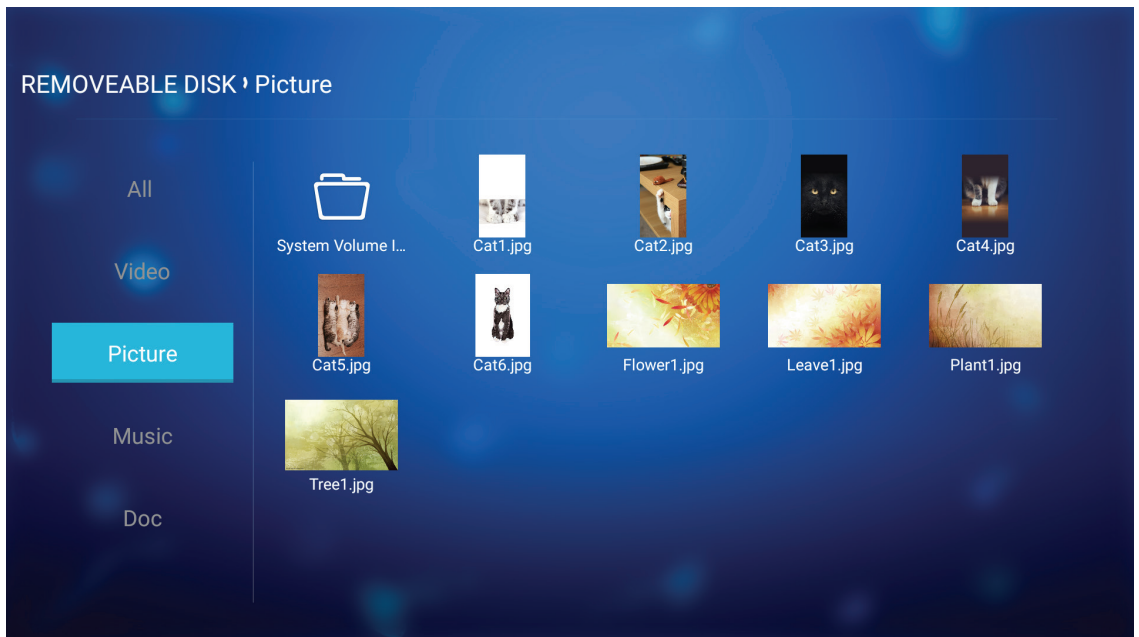

If there are several folders, press ▲▼◀▶ keys to select the desired folder, then press **Enter/↵** to view the subfolder content.

2. Press ▲▼◀▶ keys select a photo, then press **Enter/↵** to view the photo in full screen.

Photo Options

While viewing the photo in full screen:

- Use ◀▶ keys to view the previous or next photo.
- Press **Enter/↵** to access the quick menu.

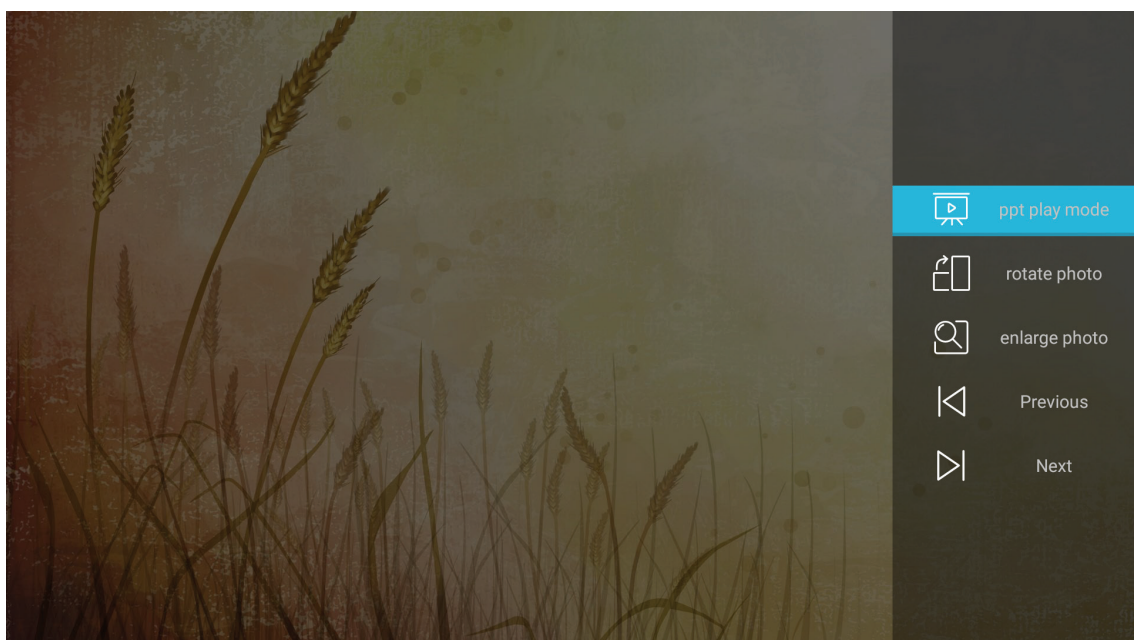

- Select **ppt play mode** to configure the slide show settings.
- Select **rotate photo** to rotate the photo 90-degree clockwise.

USING THE PROJECTOR

- Select **enlarge photo** to magnify the view of a photo.
- Select **Previous** to view the previous photo.
- Select **Next** to view the next photo.

Slide show Settings

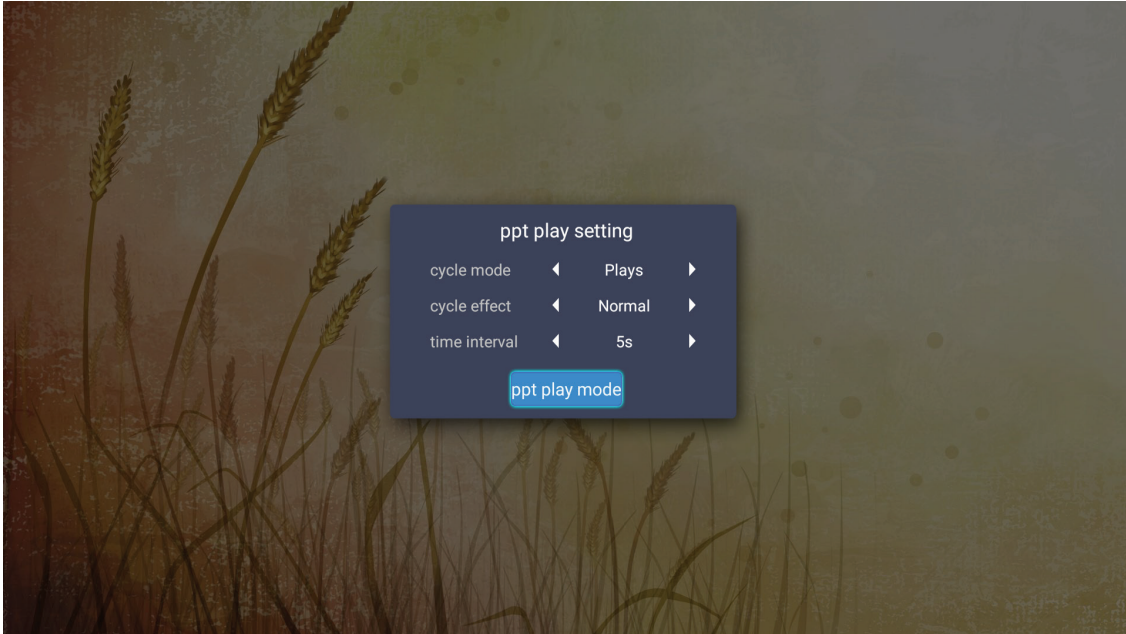

cycle mode

Set the slide show mode option.

cycle effect

Select the transition effect between each slide displays.

time interval

Set the interval time between each slide displays.

ppt play interval

Select to start the slide show.

Note:

- To pause the slide show, press Enter/ ↵.
- To stop the slide show, press ↶.

USING THE PROJECTOR

Playing Music

1. From the left panel, select **Music** to browse all songs or audio files.

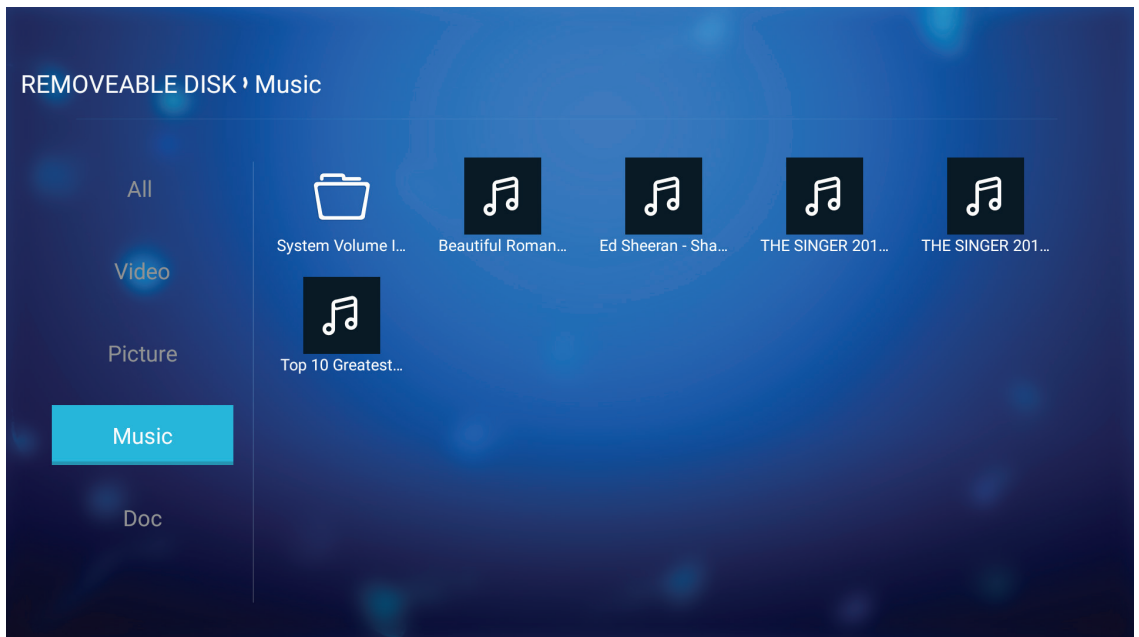

If there are several folders, press ▲▼◀▶ keys to select the desired folder, then press **Enter/↵** to view the subfolder content.

2. Press ▲▼◀▶ keys to select the song you want play, then press **Enter/↵** to start the playback.

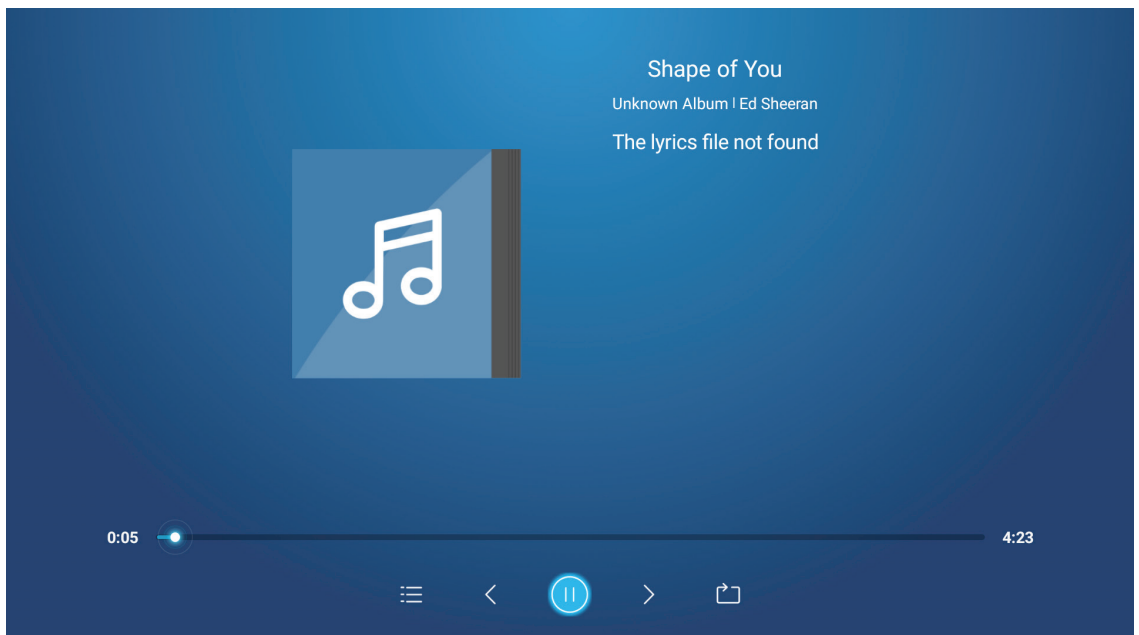

- To pause the playback, select ⏸ and press **Enter/↵**. To resume, select ▶ and press **Enter/↵**.
- To skip to the previous/next track, select ⏮/⏭ and press **Enter/↵**.
- To switch the play mode, select 🔄 and press **Enter/↵** repeatedly to select the desired mode.
- To view the playlist, select ☰ and press **Enter/↵**.
- To stop playback at any time, press ⏹.

USING THE PROJECTOR

Viewing Document

1. From the left panel, select **Doc** to browse all document files.

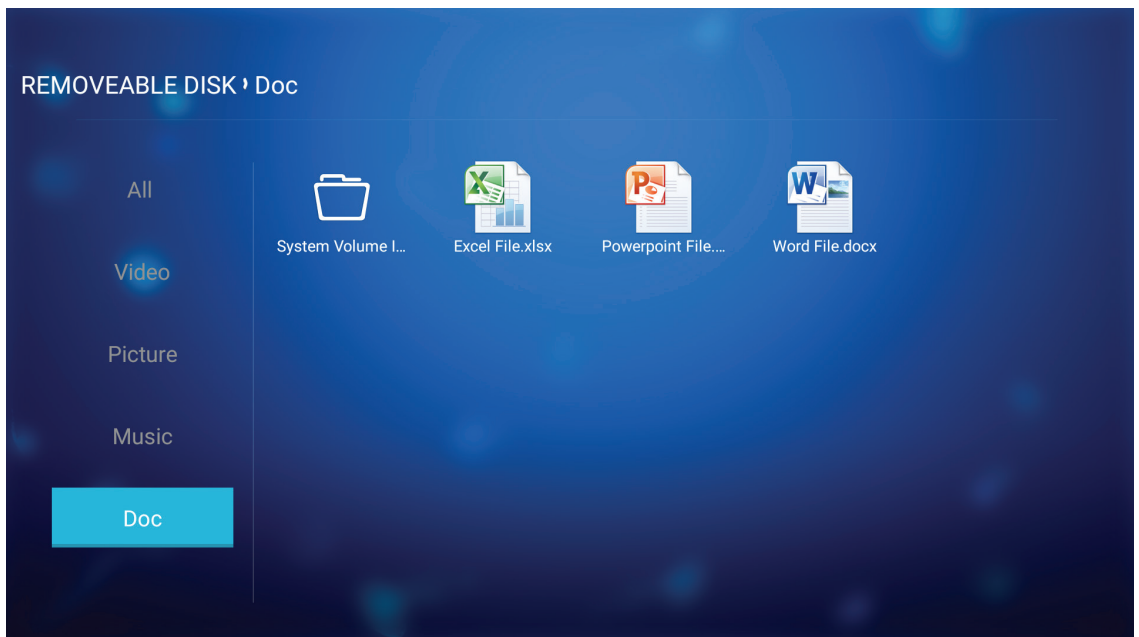

If there are several folders, press ▲▼◀▶ keys to select the desired folder, then press **Enter/↵** to view the subfolder content.

2. Press ▲▼◀▶ keys to select the document you want to view, then press **Enter/↵** to open the file.

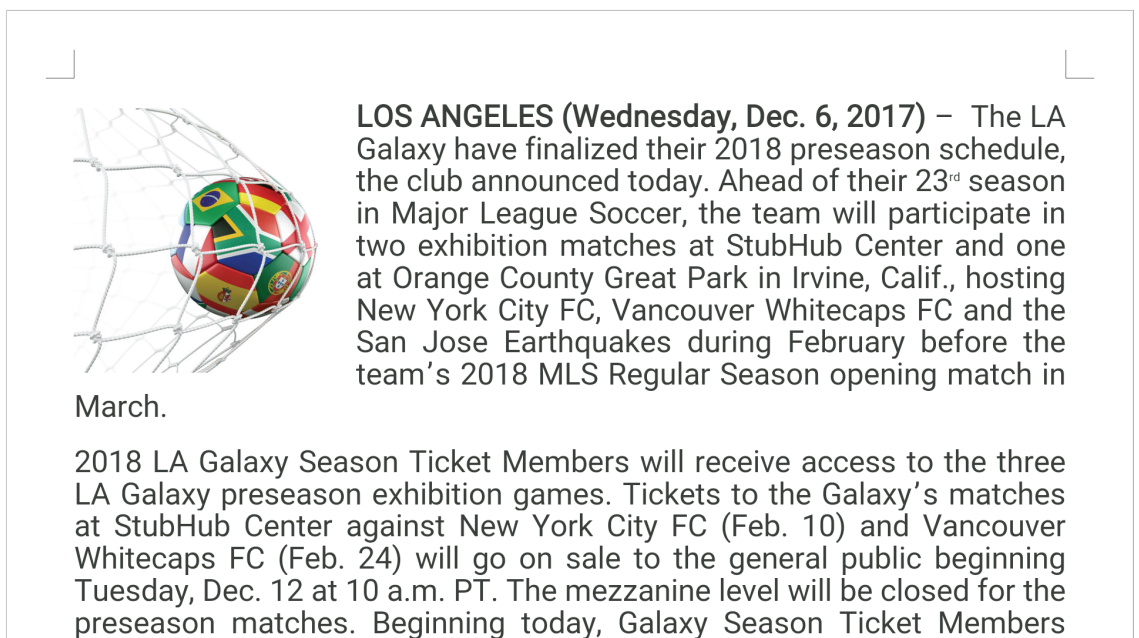

- Press ▲▼◀▶ keys to scroll the page up/down or navigate the page.
- To close the document at any time, press ↶.

USING THE PROJECTOR

Note: When opening a Powerpoint file, the Play Mode menu will appear on the screen. Then select the desired play mode and select **OK** to start browsing the file.

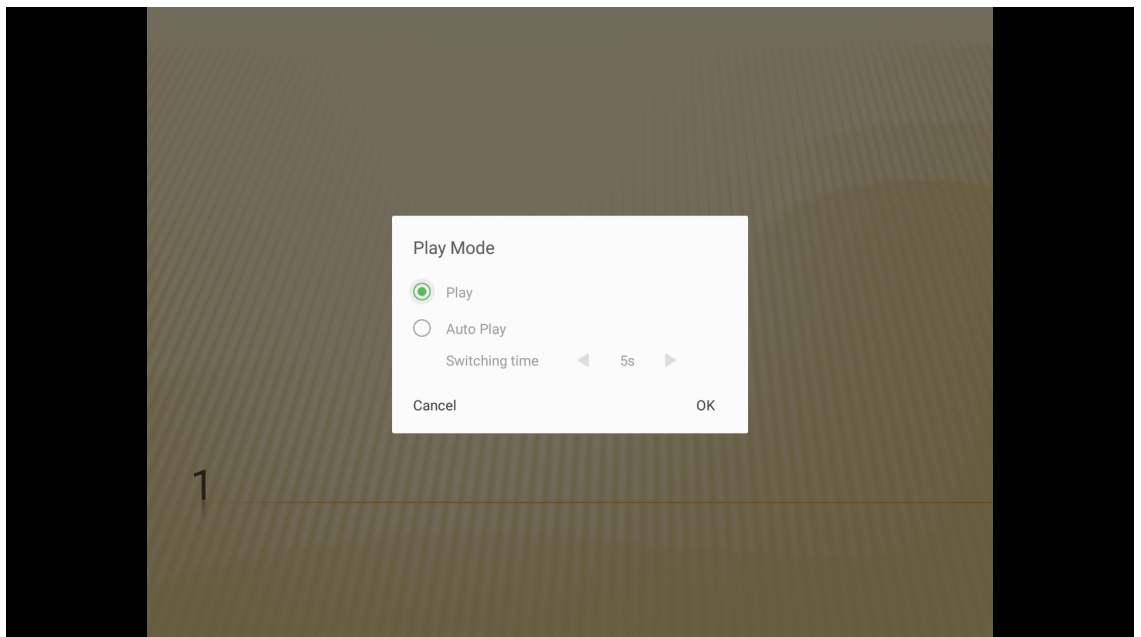

USING THE PROJECTOR

Wireless Media Streaming

Select **Wi-Fi Display** to project your mobile device display to the projector through Wi-Fi connection. Then press **Enter** on the remote control or **↵** on the projector keypad to enter the **EZCast** screen.

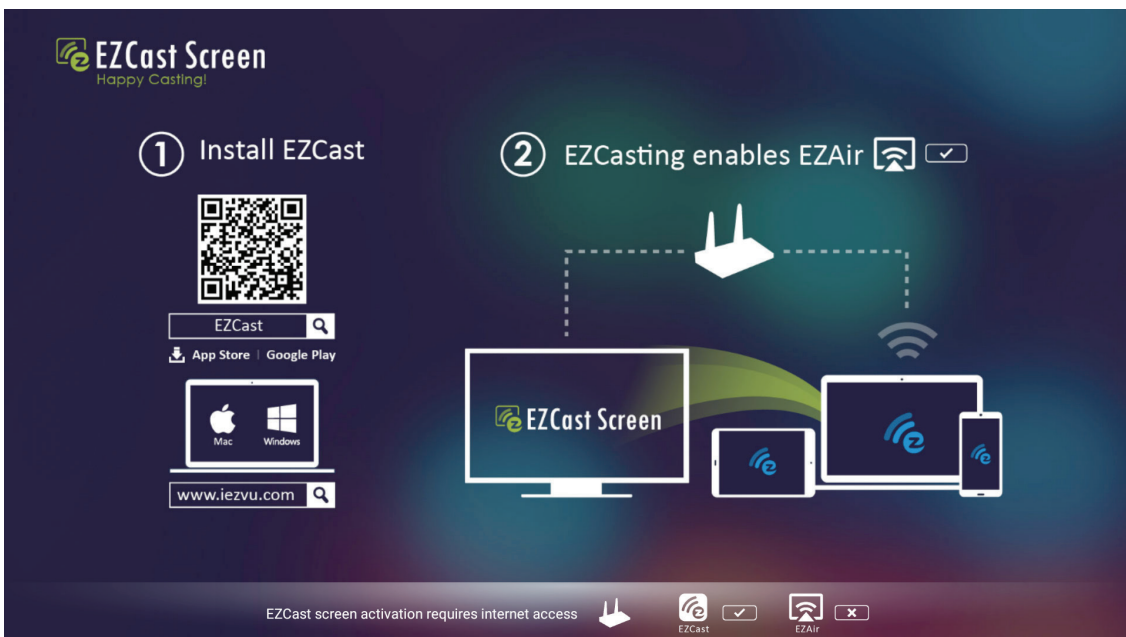
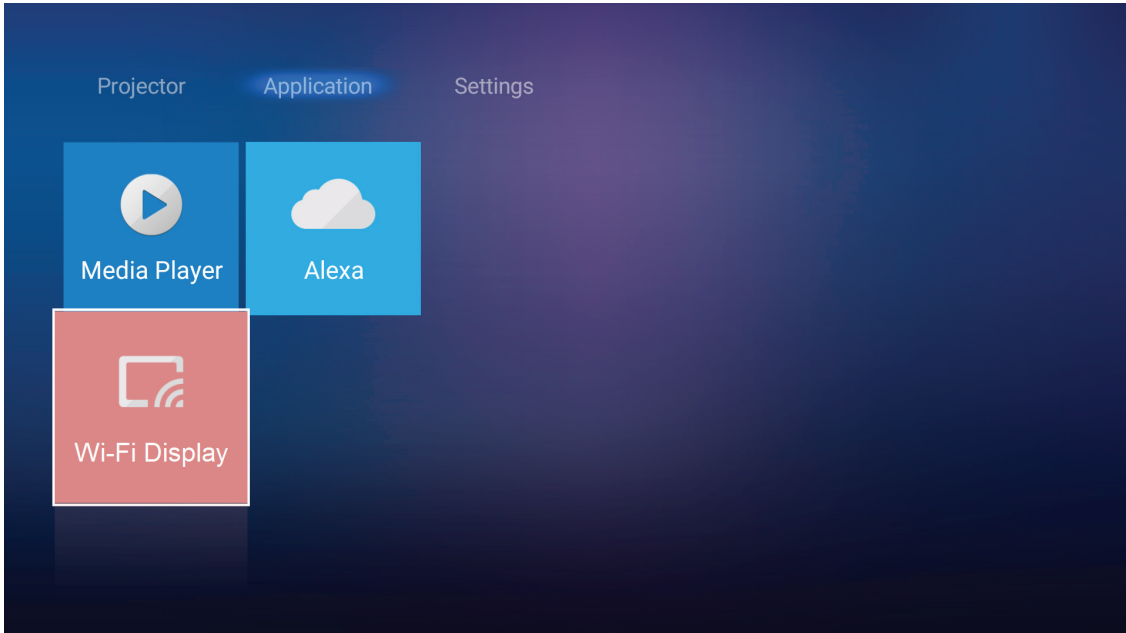

1. When using Wi-Fi Display function for the first time, download and install the EZCast application into your mobile device.
Note: You can scan the QR code shown on the screen or download from the App Store or Google Play.
2. On the projector, insert the Wi-Fi dongle and go to **Settings > Network > Wireless Setting (Wi-Fi Display)**. Then set the **Wi-Fi** setting to ON.
3. Connect the projector to an available network. For details, please refer to page 48.
4. On your mobile device, enable the Wi-Fi function. Then connect to the same network as the projector.
IMPORTANT!
 - The projector and your mobile device must be connected to the same Wi-Fi network.
 - During the Wi-Fi Display operation, make sure that you have access to the internet.

USING THE PROJECTOR

Note: The connection method may vary depending on the dongle type. Please refer to its documentation for details.

5. Launch “EZCast” application and connect to your dongle.
6. Once connected, the mobile device display will be projected on the screen.

General settings

On the **Settings** home screen, you can set the on-screen display (OSD) language and configure the network settings. To switch to the **Settings** home screen, select one of the main categories and use ◀▶ keys to select **Settings**.

Changing the OSD language

Select **Language** to set the on-screen display language. Then press **Enter** on the remote control or ↵ on the projector keypad to enter the **Language** menu.

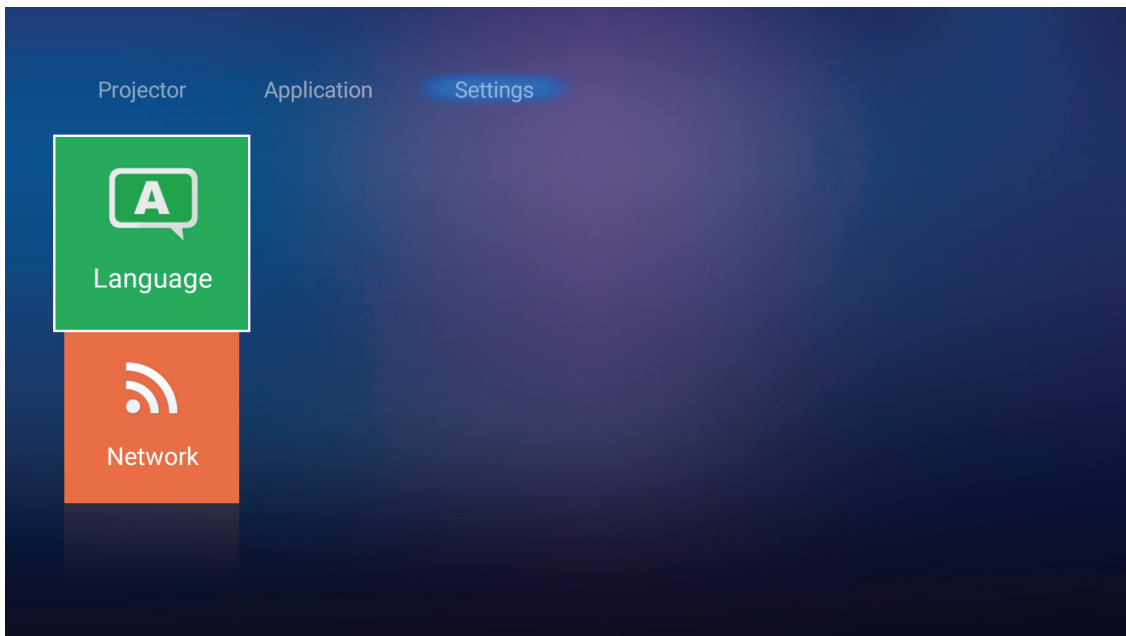

The available languages appear on the screen. Select the desired language and press **Enter**/↵ to confirm the selection.

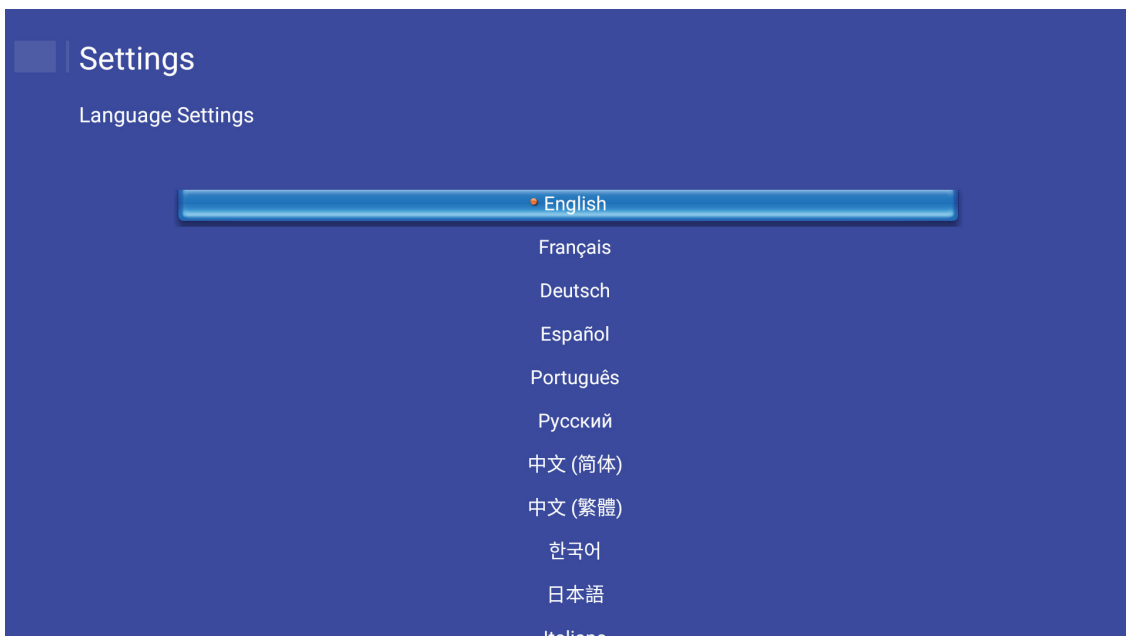

USING THE PROJECTOR

Configuring the network settings

Select **Network** to configure the network setting. Then press **Enter** on the remote control or **↵** on the projector keypad to enter the **Network** menu.

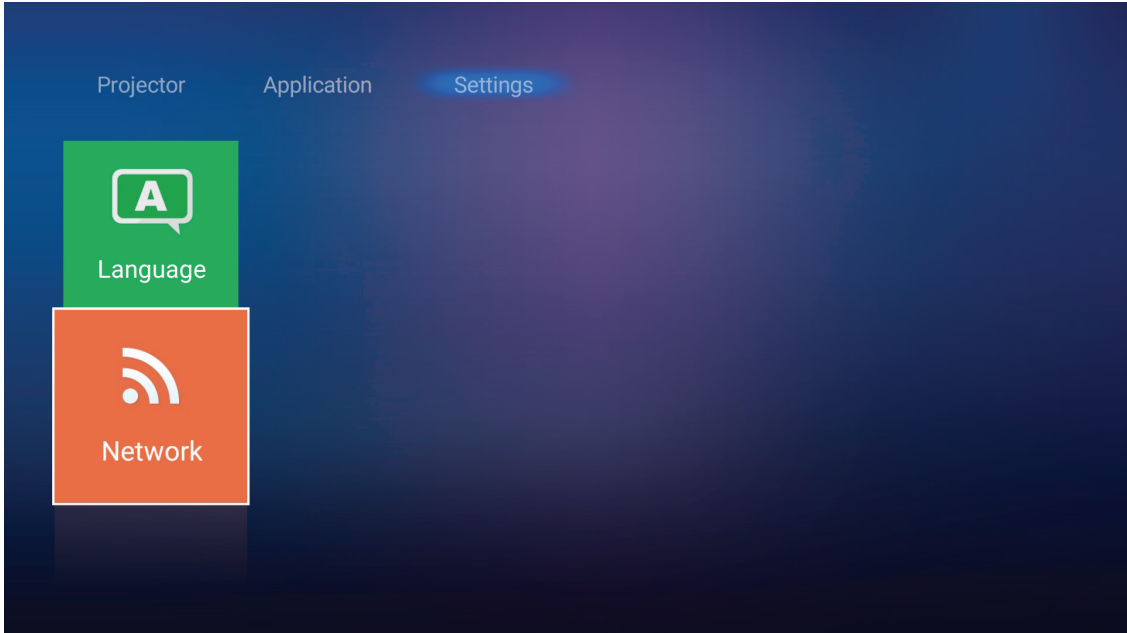

Select **Projector Control Settings**. Then perform the necessary settings.

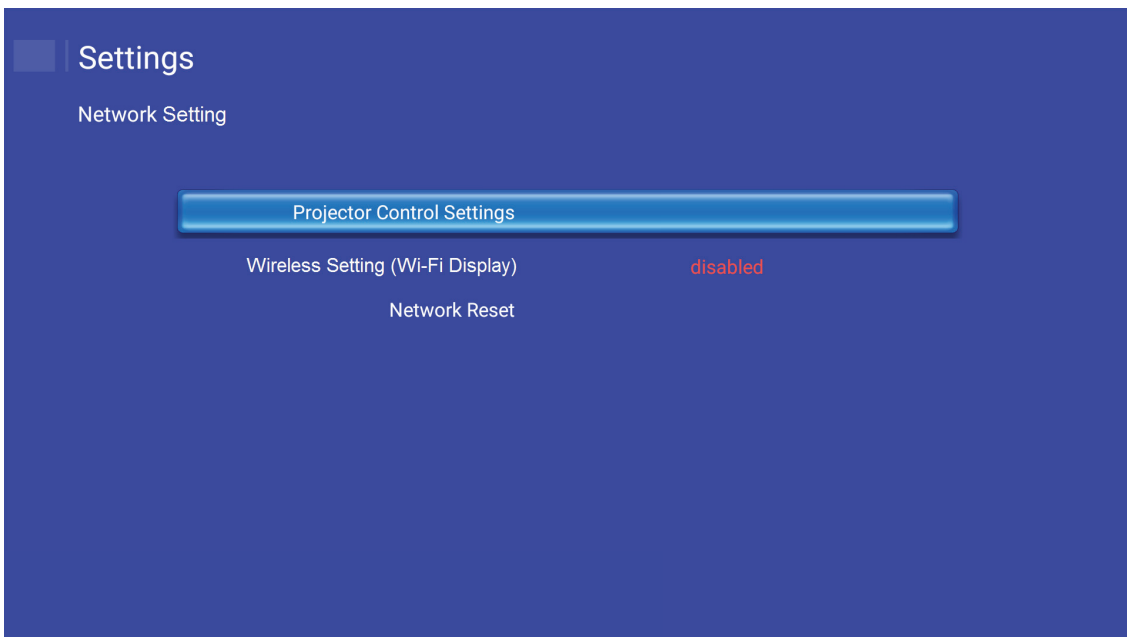

USING THE PROJECTOR

Note: To configure the wireless connection, select **Wireless Setting (Wi-Fi Display)** and do the following:

a. Insert a Wi-Fi dongle first, and then enable the Wi-Fi function.

b. Connect to an available Wi-Fi network from the list.

If you connect to a secure Wi-Fi network, you must enter the password when prompted.

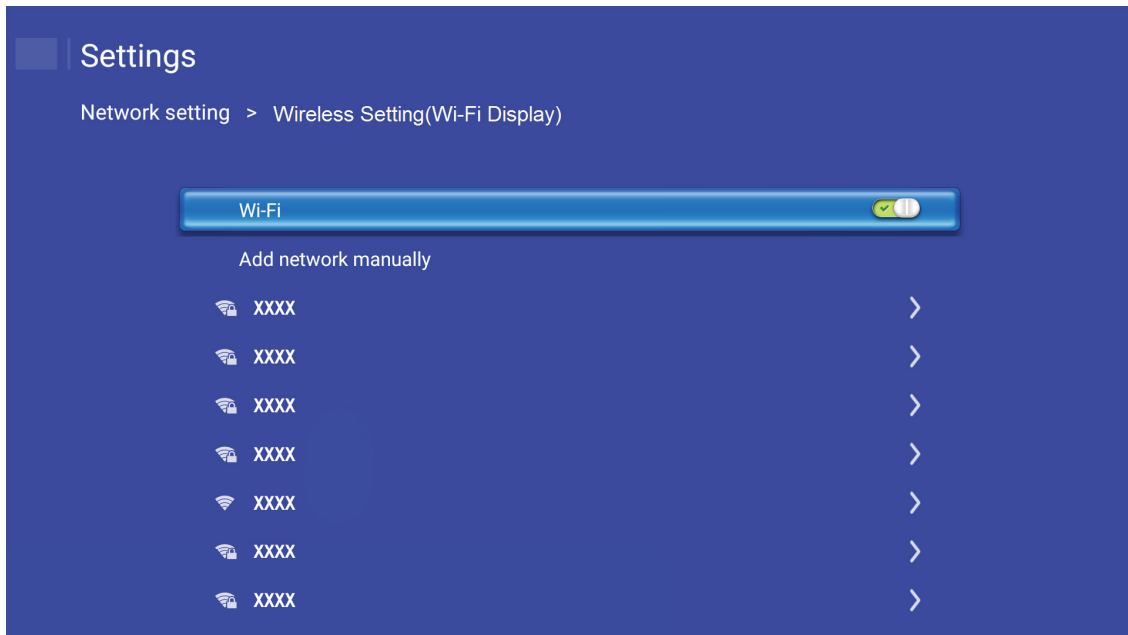

USING THE PROJECTOR

LAN RJ45 function

For simplicity and ease of operation, the projector provides diverse networking and remote management features.

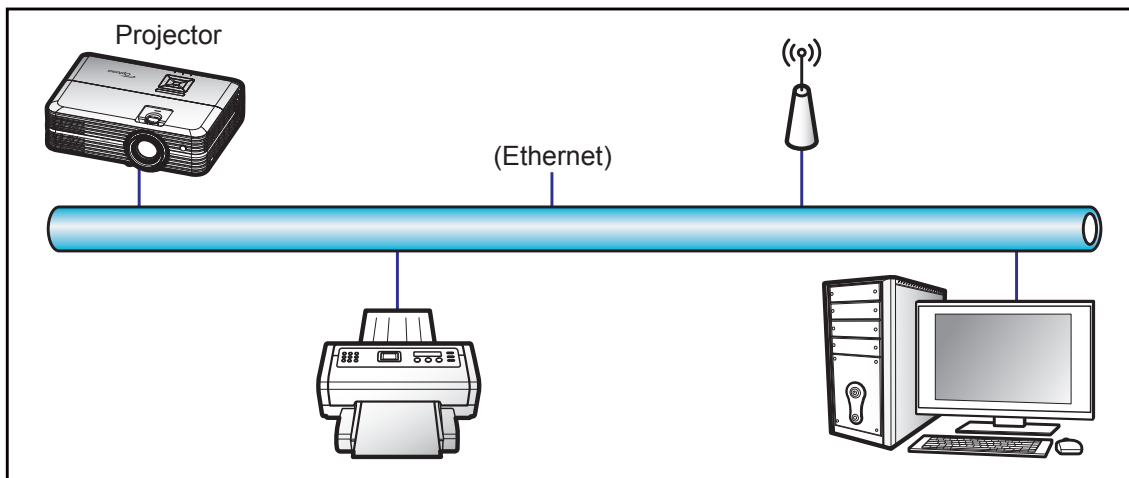

Wired LAN terminal functionalities

This projector can be controlled by using a PC (laptop) or other external device via LAN / RJ45 port and compatible with Crestron / Extron / AMX (Device -Discovery) / PJLink.

- Crestron is a registered trademark of Crestron Electronics, Inc. of the United States.
- Extron is a registered trademark of Extron Electronics, Inc. of the United States.
- AMX is a registered trademark of AMX LLC of the United States.
- PJLink applied for trademark and logo registration in Japan, the United States of America, and other countries by JBMIA.

The projector is supported by the specified commands of the Crestron Electronics controller and related software, for example RoomView®.

<http://www.crestron.com/>

This projector is compliant to support Extron device(s) for reference.

<http://www.extron.com/>

This projector is supported by AMX (Device Discovery).

<http://www.amx.com/>

This projector supports all commands of PJLink Class1 (Version 1.00).

<http://pjlink.jbmia.or.jp/english/>

For more detailed information about the various types of external devices which can be connected to the LAN / RJ45 port and remote control the projector, as well as the supported commands for these external devices, please contact the Support-Service directly.

USING THE PROJECTOR

Ethernet Settings

Configure the network parameters.

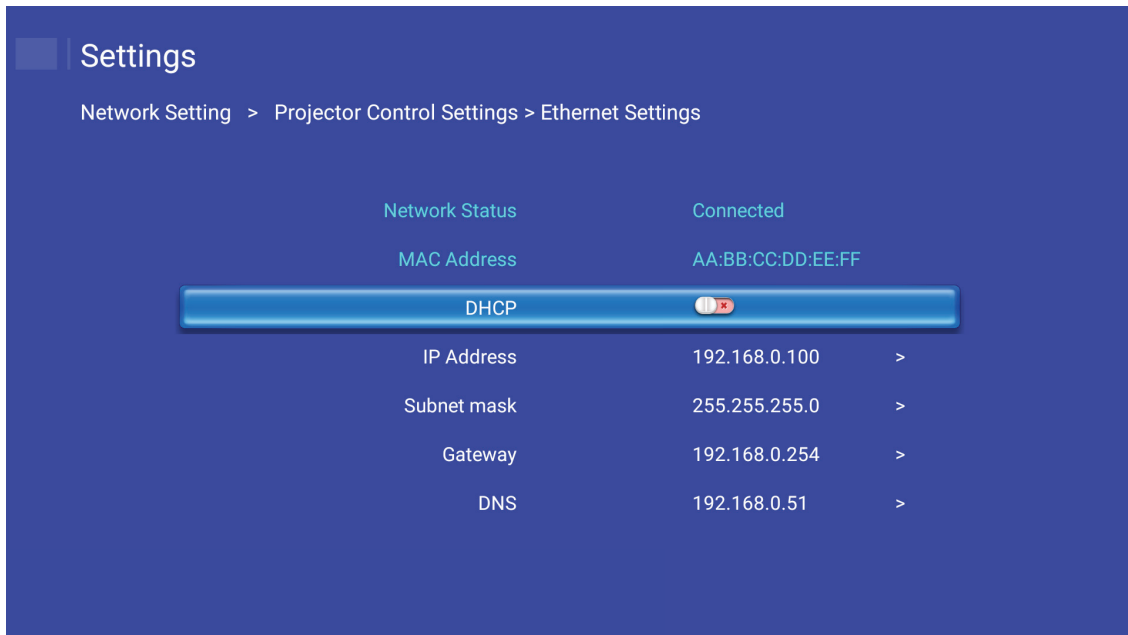

- DHCP: Off
- IP Address: 192.168.0.100
- Subnet Mask: 255.255.255.0
- Gateway: 192.168.0.254
- DNS: 192.168.0.51

Wireless Settings

Select the wireless network you want to connect to control the projector wirelessly through various protocols including Alexa.

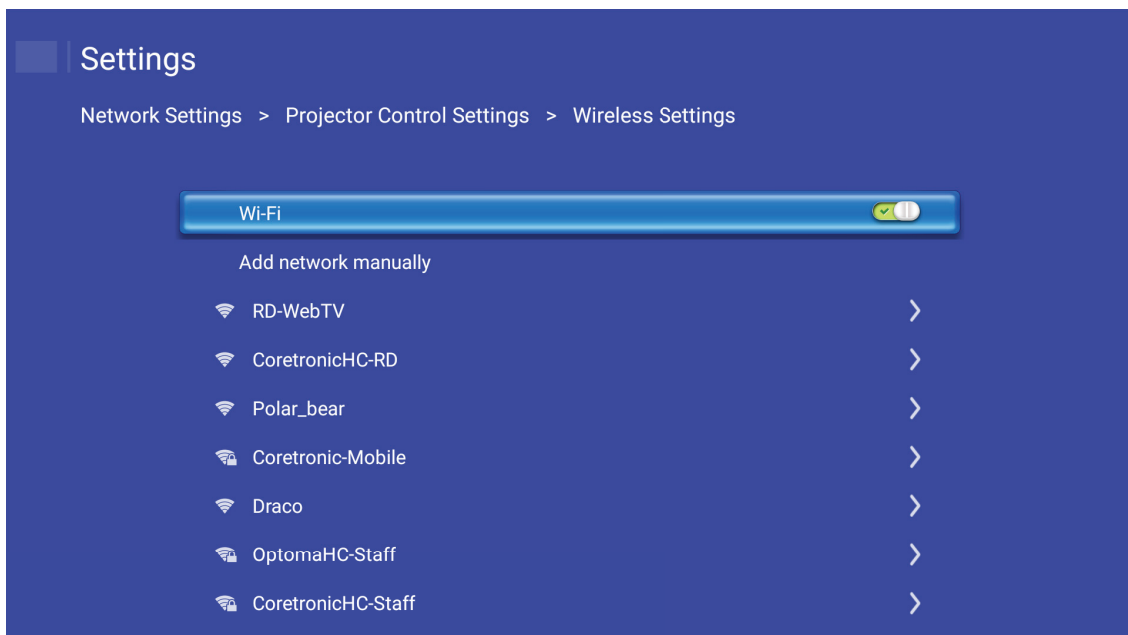

USING THE PROJECTOR

Projector Control Functions

Configure how to monitor and control your projector over the network.

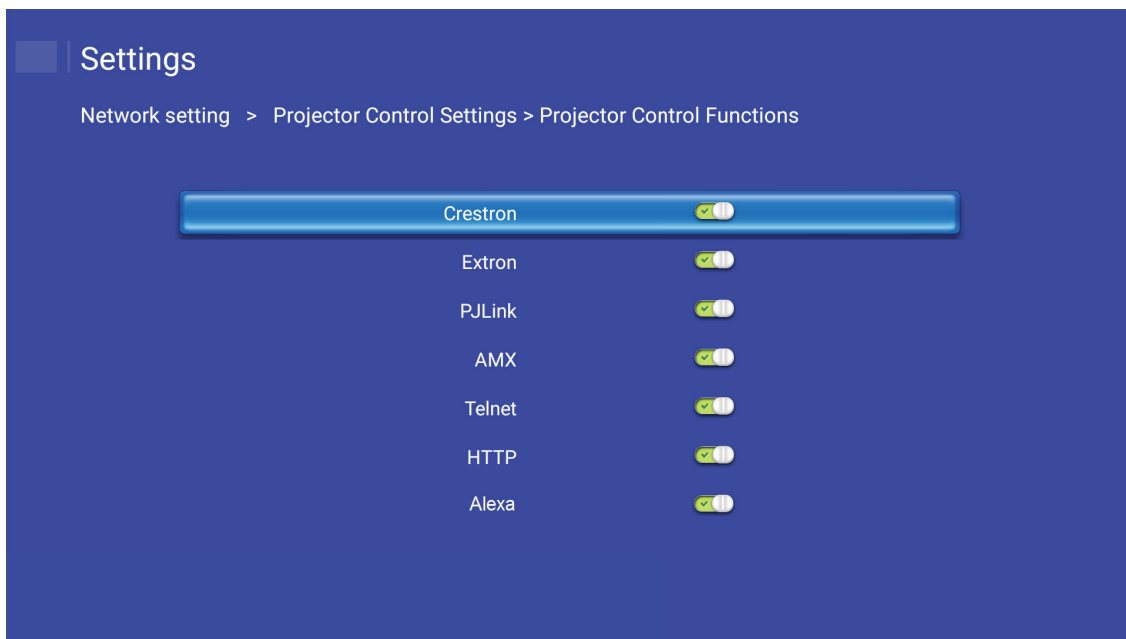

MAINTENANCE

Replacing the lamp

The projector automatically detects the lamp life. When the lamp life is nearing the end of use, a warning message will appear on the screen.



When you see this message, please contact your local reseller or service center to change the lamp as soon as possible. Make sure the projector has been cooled down for at least 30 minutes before changing the lamp.



Warning: If ceiling mounted, please use caution when opening the lamp access panel. It is recommended to wear safety glasses if changing the bulb when ceiling mounted. Caution must be used to prevent any loose parts from falling out of projector.



Warning: Lamp compartment is hot! Allow it to cool down before changing lamp!



Warning: To reduce the risk of personal injury, do not drop the lamp module or touch the lamp bulb. The bulb may shatter and cause injury if it is dropped.

MAINTENANCE

Replacing the lamp (continued)

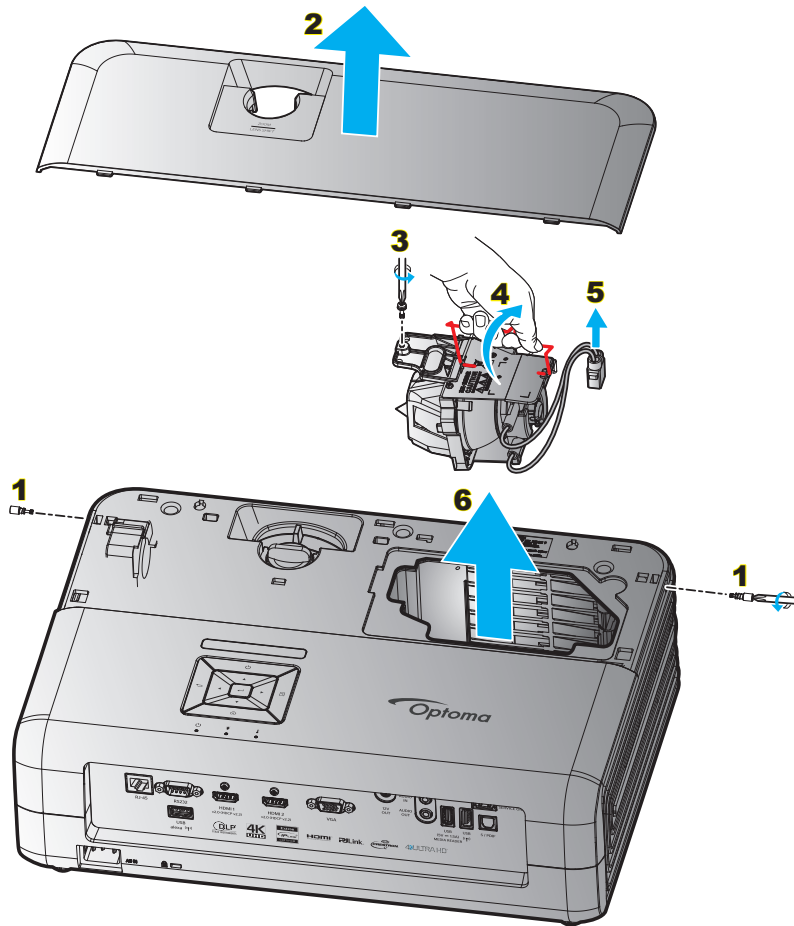

Procedure:

1. Switch off the power to the projector by pressing the “ $\text{\textcircled{P}}$ ” button on the projector keypad or the remote control.
2. Allow the projector to cool down for at least 30 minutes.
3. Disconnect the power cord.
4. Remove the 2 screws securing the top cover. **1**
5. Remove the top cover. **2**
6. Remove the screw on the lamp module. **3**
7. Lift up the lamp handle. **4**
8. Remove the lamp cord. **5**
9. Remove the lamp module carefully. **6**
10. To replace the lamp module, reverse the previous steps.
11. Turn on the projector and reset the lamp timer.
12. Lamp Reset: (i) Press “Menu” → (ii) Select “Projector Settings” → (iii) Select “Lamp Settings” → (iv) Select “Lamp Reset” → (v) Select “Yes”.

Note:

- The projector cannot be turned on if the lamp cover has not been placed back on the projector.
- Do not touch the glass area of the lamp. Hand oil can cause the lamp shatter. Use a dry cloth to clean the lamp module if it was accidentally touched.

MAINTENANCE

Installing and cleaning the dust filter

Installing the dust filter

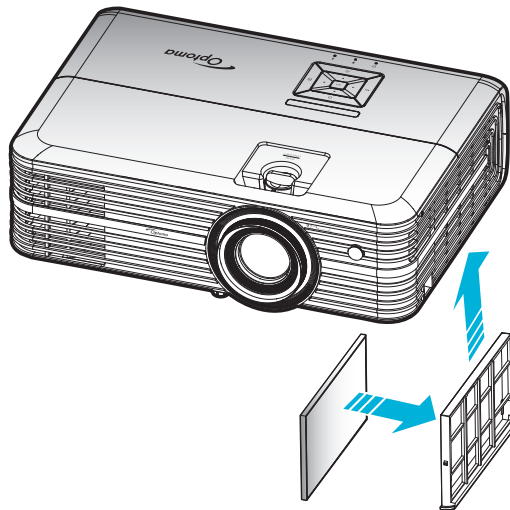

Note: Dust filters are only required/supplied in the selected regions with excessive dust.

Cleaning the dust filter

We recommend you to clean the dust filter every three months. Clean it more often if the projector is used in a dusty environment.

Procedure:

1. Switch off the power to the projector by pressing the “ $\text{\textcircled{P}}$ ” button on the projector keypad or the remote control.
2. Disconnect the power cord.
3. Pull the dust filter compartment downwards to remove it out from the bottom of the projector. **1**
4. Carefully remove the air filter. Then clean or replace the dust filter. **2**
5. To install the dust filter, reverse the previous steps.

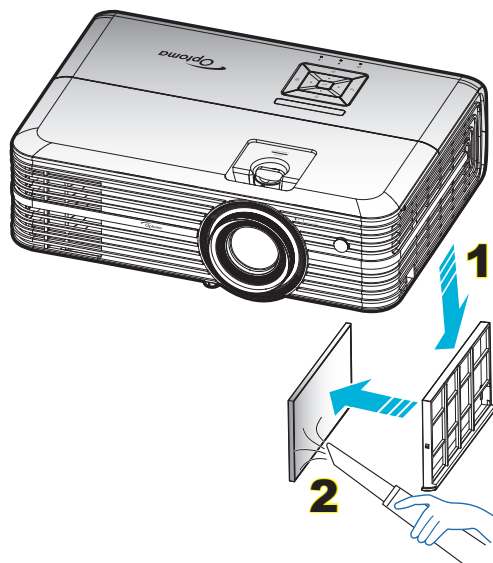

ADDITIONAL INFORMATION

Compatible resolutions

Digital (HDMI 1.4)

Native resolution: 1920 x 1080 @ 60Hz

Established Timing	Standard Timing	Descriptor Timing	Supported Video Mode	Detail Timing
720 x 400 @ 70Hz	1280 x 720 @ 60Hz	1920 x 1080 @ 60Hz (default)	720 x 480i @ 60Hz 16:9	1920 x 1080p @ 60Hz
640 x 480 @ 60Hz	1280 x 800 @ 60Hz		720 x 480p @ 60Hz 4:3	
640 x 480 @ 67Hz	1280 x 1024 @ 60Hz		720 x 480p @ 60Hz 16:9	
640 x 480 @ 72Hz	1920 x 1200 @ 60Hz (reduced)		720 x 576i @ 50Hz 16:9	
640 x 480 @ 75Hz	1366 x 768 @ 60Hz		720 x 576p @ 50Hz 4:3	
800 x 600 @ 56Hz			720 x 576p @ 50Hz 16:9	
800 x 600 @ 60Hz			1280 x 720p @ 60Hz 16:9	
800 x 600 @ 72Hz			1280 x 720p @ 50Hz 16:9	
800 x 600 @ 75Hz			1920 x 1080i @ 60Hz 16:9	
832 x 624 @ 75Hz			1920 x 1080i @ 50Hz 16:9	
1024 x 768 @ 60Hz			1920 x 1080p @ 60Hz 16:9	
1024 x 768 @ 70Hz			1920 x 1080p @ 50Hz 16:9	
1024 x 768 @ 75Hz			1920 x 1080p @ 24Hz 16:9	
1280 x 1024 @ 75Hz			3840 x 2160 @ 24Hz	
1152 x 870 @ 75Hz			3840 x 2160 @ 25Hz	
			3840 x 2160 @ 30Hz	
			4096 x 2160 @ 24Hz	

Digital (HDMI 2.0)

Native resolution: 1920 x 1080 @ 60Hz

B0 / Established Timing	B0 / Standard Timing	B1 / Video Mode	B1 / Detail Timing
720 x 400 @ 70Hz	1280 x 720 @ 60Hz	720 x 480i @ 60Hz 16:9	1920 x 1080p @ 60Hz
640 x 480 @ 60Hz	1280 x 800 @ 60Hz	720 x 480p @ 60Hz 4:3	
640 x 480 @ 67Hz	1280 x 1024 @ 60Hz	720 x 480p @ 60Hz 16:9	
640 x 480 @ 72Hz	1920 x 1200 @ 60Hz (reduced)	720 x 576i @ 50Hz 16:9	
640 x 480 @ 75Hz	1366 x 768 @ 60Hz	720 x 576p @ 50Hz 4:3	
800 x 600 @ 56Hz		720 x 576p @ 50Hz 16:9	
800 x 600 @ 60Hz		1280 x 720p @ 60Hz 16:9	
800 x 600 @ 72Hz		1280 x 720p @ 50Hz 16:9	
800 x 600 @ 75Hz		1920 x 1080i @ 60Hz 16:9	
832 x 624 @ 75Hz		1920 x 1080i @ 50Hz 16:9	
1024 x 768 @ 60Hz		1920 x 1080p @ 60Hz 16:9	
1024 x 768 @ 70Hz		1920 x 1080p @ 50Hz 16:9	
1024 x 768 @ 75Hz		1920 x 1080p @ 24Hz 16:9	
1280 x 1024 @ 75Hz		3840 x 2160 @ 24Hz	
1152 x 870 @ 75Hz		3840 x 2160 @ 25Hz	
		3840 x 2160 @ 30Hz	
		3840 x 2160 @ 50Hz	
		3840 x 2160 @ 60Hz	
		4096 x 2160 @ 24Hz	
		4096 x 2160 @ 25Hz	

ADDITIONAL INFORMATION

B0 / Established Timing	B0 / Standard Timing	B1 / Video Mode	B1 / Detail Timing
		4096 x 2160 @ 30Hz	
		4096 x 2160 @ 50Hz	
		4096 x 2160 @ 60Hz	

Note: Support 1920 x 1080 @ 50Hz.

Analog

Native resolution: 1920 x 1080 @ 60Hz

B0 / Established Timing	B0 / Standard Timing	B0 / Detail Timing	B1 / Detail Timing
720 x 400 @ 70Hz	1280 x 720 @ 60Hz	1920 x 1080 @ 60Hz (default)	1366 x 768 @ 60Hz
640 x 480 @ 60Hz	1280 x 800 @ 60Hz		
640 x 480 @ 67Hz	1280 x 1024 @ 60Hz		
640 x 480 @ 72Hz	1400 x 1050 @ 60Hz		
640 x 480 @ 75Hz	1600 x 1200 @ 60Hz		
800 x 600 @ 56Hz			
800 x 600 @ 60Hz			
800 x 600 @ 72Hz			
800 x 600 @ 75Hz			
832 x 624 @ 75Hz			
1024 x 768 @ 60Hz			
1024 x 768 @ 70Hz			
1024 x 768 @ 75Hz			
1280 x 1024 @ 75Hz			
1152 x 870 @ 75Hz			

Note: Support 1920 x 1080 @ 50Hz.

ADDITIONAL INFORMATION

Image size and projection distance

Diagonal length (inch) size of 16:9 Screen	Screen Size W x H				Projection Distance (D)				Offset (HD)	
	(m)		(inch)		(m)		(feet)		(m)	(feet)
	Width	Height	Width	Height	Wide	Tele	Wide	Tele		
30	0.66	0.37	25.97	14.61	-	1.05	-	3.44	0.02	0.07
40	0.89	0.50	34.86	19.61	1.07	1.41	3.51	4.62	0.03	0.09
60	1.33	0.75	52.29	29.42	1.61	2.11	5.27	6.93	0.04	0.13
70	1.55	0.87	61.01	34.32	1.88	2.46	6.15	8.08	0.05	0.16
80	1.77	1.00	69.73	39.22	2.14	2.82	7.03	9.23	0.05	0.18
90	1.99	1.12	78.44	44.12	2.41	3.17	7.91	10.39	0.06	0.20
100	2.21	1.25	87.16	49.03	2.68	3.52	8.78	11.54	0.07	0.22
120	2.66	1.49	104.59	58.83	3.21	4.22	10.54	13.85	0.08	0.27
150	3.32	1.87	130.74	73.54	4.02	5.28	13.18	17.31	0.10	0.34
180	3.98	2.24	156.88	88.25	4.82	6.34	15.81	20.78	0.12	0.40
200	4.43	2.49	174.32	98.05	5.36	7.04	17.57	23.08	0.14	0.45
250	5.53	3.11	217.89	122.57	6.70	8.80	21.96	28.85	0.17	0.56
300.6	6.65	3.74	262.00	147.37	8.05	-	26.40	-	0.21	0.68

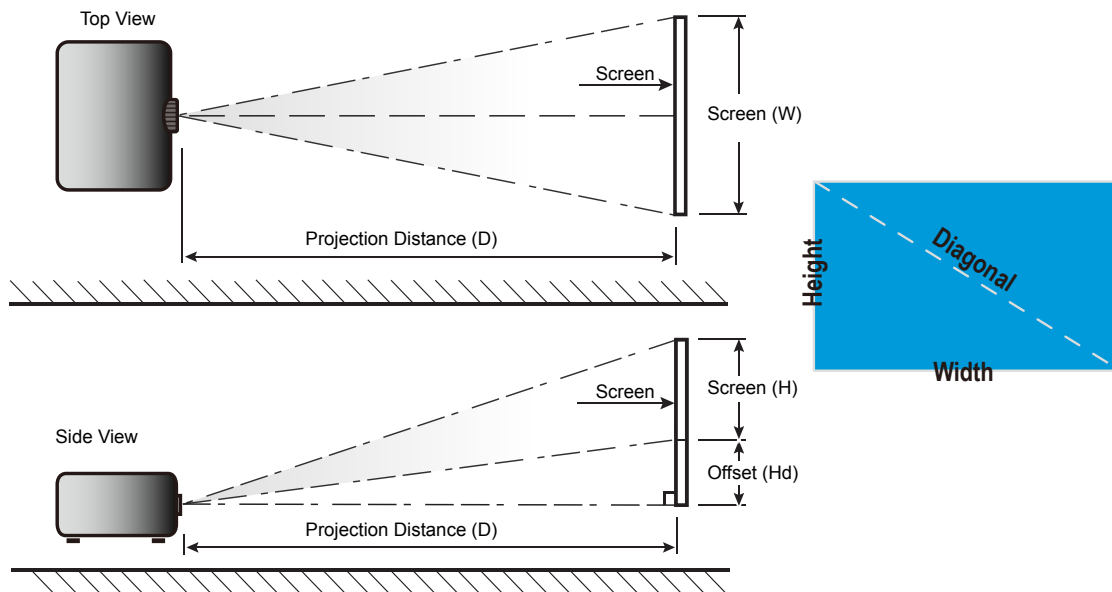

ADDITIONAL INFORMATION

Projector dimensions and ceiling mount installation

1. To prevent damage to your projector, please use the Optoma ceiling mount.
2. If you wish to use a third party ceiling mount kit, please ensure the screws used to attach a mount to the projector meet the following specifications:
 - Screw type: M4*3
 - Minimum screw length: 10mm

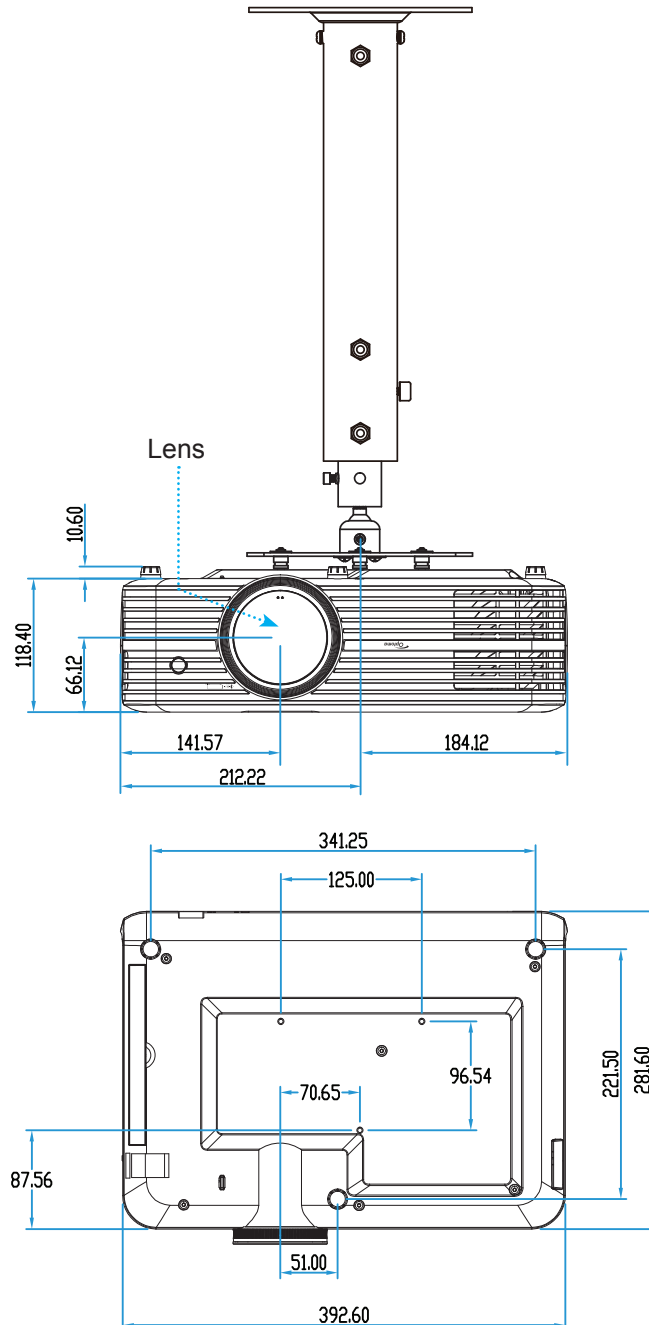

Note: Please note that damage resulting from incorrect installation will void the warranty.



Warning:

- If you buy a ceiling mount from another company, please be sure to use the correct screw size. Screw size will vary depending on the thickness of the mounting plate.
- Be sure to keep at least 10 cm gap between the ceiling and the bottom of the projector.
- Avoid installing the projector near a heat source.

ADDITIONAL INFORMATION

IR remote codes



Key	Key num	MTX.	Format	Data0	Data1	Data2	Data3	Description	
Power on / off		K12	04	F1	32	CD	71	8E	Refer to the "Power On/ Off the Projector" section on page 18.
Source		K3	11	F1	32	CD	18	E7	Press to select an input signal.
Home		K13	03	F1	32	CD	92	6D	Press to return to the Home screen.
Menu		K8	17	F1	32	CD	0E	F1	Press to launch the on-screen display (OSD) menu. To exit OSD, press again.
Return		K4	10	F1	32	CD	86	79	Press to return to the previous page.
Up		K7	18	F2	32	CD	11	EE	Use to select items or make adjustments to your selection.
Left		K14	02	F2	32	CD	10	EF	
Right		K5	09	F2	32	CD	12	ED	
Down		K2	19	F2	32	CD	14	EB	
Enter	Enter	K9	16	F1	32	CD	0F	F0	Confirm your item selection.
Mute		K15	01	F1	32	CD	52	AD	Press to turn off/on the projector built-in speaker.
Display Mode		K10	15	F1	32	CD	91	6E	Press to display the Display Mode menu. To exit the Display Mode menu, press again.
Option		K6	08	F1	32	CD	25	DA	Press to configure the Smart TV settings.
Volume -		K11	12	F2	32	CD	0C	F3	Press to decrease the volume.
Volume +		K1	05	F2	32	CD	09	F6	Press to increase the volume.

ADDITIONAL INFORMATION

Troubleshooting

If you experience a problem with your projector, please refer to the following information. If a problem persists, please contact your local reseller or service center.

Image problems

- ❓ *No image appears on-screen*
 - Ensure all the cables and power connections are correctly and securely connected as described in the "Installation" section.
 - Ensure the pins of connectors are not crooked or broken.
 - Check if the projection lamp has been securely installed. Please refer to the "Replacing the Lamp" section on pages 52-53.
 - Ensure that the "Mute" feature is not turned on.

- ❓ *Image is out of focus*
 - Adjust the Focus Ring on the projector lens. Please see page 16.
 - Make sure the projection screen is between the required distance from the projector. (Please refer to page 57).

- ❓ *The image is stretched when displaying 16:9 DVD title*
 - When you play anamorphic DVD or 16:9 DVD, the projector will show the best image in 16: 9 format on projector side.
 - If you play 4:3 format DVD title, please change the format as 4:3 in projector OSD.
 - Please setup the display format as 16:9 (wide) aspect ratio type on your DVD player.

- ❓ *Image is too small or too large*
 - Adjust the zoom lever on the top of the projector.
 - Move the projector closer to or further from the screen.
 - Press "Menu" on the projector panel, go to "Display Settings-->Aspect Ratio". Try the different settings.

- ❓ *Image has slanted sides:*
 - If possible, reposition the projector so that it is centered on the screen and below the bottom of the screen.

- ❓ *Image is reversed*
 - Select "Projector Settings-->Projection Mode" from the OSD and adjust the projection direction.

- ❓ *Blurry double image*
 - Make sure "Display Mode" is not 3D to avoid normal 2D image appear blurry double image.

ADDITIONAL INFORMATION

Two images, side-by-side format

- Set the "3D" --> "3D Format" to "SBS".

Other problems

The projector stops responding to all controls

- If possible, turn off the projector, then unplug the power cord and wait at least 20 seconds before reconnecting power.

Lamp burns out or makes a popping sound

- When the lamp reaches its end of life, it will burn out and may make a loud popping sound. If this happens, the projector will not turn on until the lamp module has been replaced. To replace the lamp, follow the procedures in the "Replacing the Lamp" section on pages 52-53.

Remote control problems

If the remote control does not work

- Check the operating angle of the remote control is pointed within $\pm 15^\circ$ (horizontally) or $\pm 10^\circ$ (vertically) to the IR receiver on the projector.
- Make sure there are not any obstructions between the remote control and the projector. Move to within 7 m (~22 ft) of the projector.
- Make sure battery is inserted correctly.
- Replace battery if it is exhausted.

ADDITIONAL INFORMATION

Warning indicators

When the warning indicators (see below) light up or flash, the projector will automatically shutdown:

- "LAMP" LED indicator is lit red and if "On/Standby" indicator flashes red.
- "TEMP" LED indicator is lit red and if "On/Standby" indicator flashes red. This indicates the projector has overheated. Under normal conditions, the project can be switched back on.
- "TEMP" LED indicator flashes red and if "On/Standby" indicator flashes red.

Unplug the power cord from the projector, wait for 30 seconds and try again. If the warning indicator light up or flash, please contact your nearest service center for assistance.

LED lightning messages

Message	On/Standby LED		Temp LED	Lamp LED
	(Red)	(Blue)	(Red)	(Red)
Standby state (Input power cord)	Steady light			
Power on (Warming)		Flashing (0.5 sec off / 0.5 sec on)		
Power on and Lamp lighting		Steady light		
Power off (Cooling)		Flashing (0.5 sec off / 0.5 sec on). Back to red steady light when cooling fan turns off.		
Error (Lamp failure)	Flashing			Steady light
Error (Fan failure)	Flashing		Flashing	
Error (Over temp.)	Flashing		Steady light	
Standby State (Burn in mode)		Flashing		
Burn in (Warming)		Flashing		
Burn in (Cooling)		Flashing		
Burn in (Lamp lighting)		Flashing (3 sec on / 1 sec off)		
Burn in (Lamp off)		Flashing (1 sec on / 3 sec off)		

ADDITIONAL INFORMATION

- Power off:



- Temperature warning:

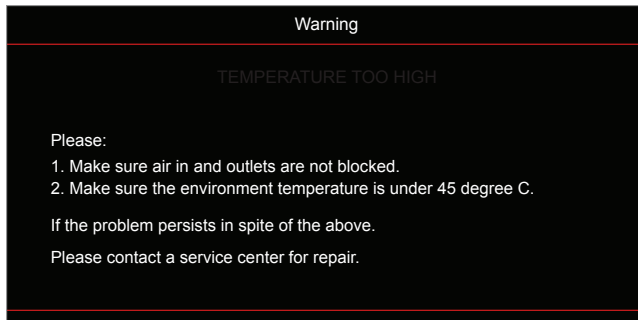

- Lamp warning:

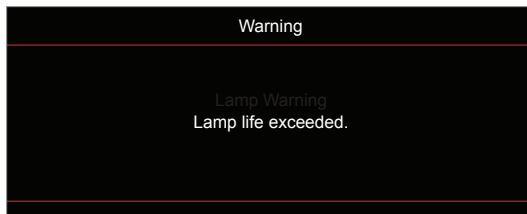

- Fan failed:

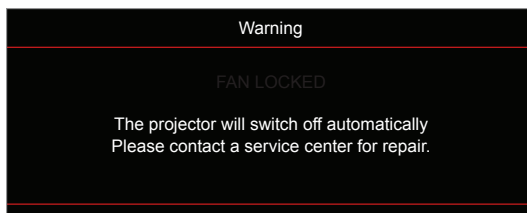

- Power down warning:

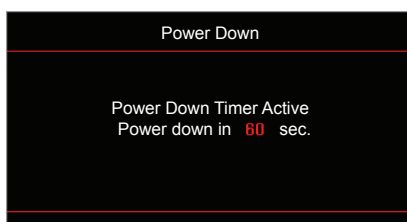

ADDITIONAL INFORMATION

Specifications

Optical	Description
Maximum resolution	- Graphic up to 2160p@60Hz - Maximum Resolution: HDMI1 (2.0): 2160p@60Hz HDMI2 (2.0): 2160p@60Hz
Native resolution	(w/o actuator) 1920x1080
Lens	Manual zoom and manual focus
Image size (diagonal)	34.1"~302.4", optimized@wide 82"(2.2m)
Projection distance	1.2~8.1m, optimized@1.61m

Electrical	Description
Inputs	- HDMI V2.0 x2 - VGA IN - Audio In 3.5mm - USB-A x2 (1 for Service, 1 for Alexa) - USB3.0 (for 5V PWR 1.5A or USB/Wi-Fi dongle) - USB2.0 - RS232C male (9-pin D-SUB) - RJ-45 (support web control)
Outputs	- Audio Out 3.5mm - SPDIF Out - 12V Trigger (3.5mm jack)
Color reproduction	1073.4 Million color
Scan rate	Horizontal scan rate: 15.375 ~ 91.146 KHz Vertical scan rate: 24 ~ 85 Hz (120Hz for 3D feature projector)
Built-in speaker	2x 5W speakers
Power requirement	100 - 240V ±10%, AC 50/60Hz
Input current	3.8A-1.0A

Mechanical	Description
Installation orientation	Front, Rear, Ceiling - Front, Rear - top
Dimensions (W x D x H)	- 392.6 x 281.6 x 118.4 mm (without feet) - 392.6 x 281.6 x 129 mm (with feet)
Weight	6.5 ±0.5 kg
Environmental conditions	Operating in 5 ~ 40°C , 10% to 85% humidity (non-condensing)

Note: All specifications are subject to change without notice.

ADDITIONAL INFORMATION

Setup Alexa



To setup and link your Alexa Projector, please scan the QR code or visit the URL:
<https://www.optoma.com/support/download>



ADDITIONAL INFORMATION

Optoma global offices

For service or support, please contact your local office.



USA

3178 Laurelview Ct.
Fremont, CA 94538, USA
www.optomausa.com

 888-289-6786
 510-897-8601
 services@optoma.com



Canada

3178 Laurelview Ct.
Fremont, CA 94538, USA
www.optomausa.com

 888-289-6786
 510-897-8601
 services@optoma.com

Latin America

3178 Laurelview Ct.
Fremont, CA 94538, USA
www.optomausa.com

 888-289-6786
 510-897-8601
 services@optoma.com



Europe

Unit 1, Network 41, Bourne End Mills,
Hemel Hempstead, Herts,
HP1 2UJ, United Kingdom
www.optoma.eu
Service Tel : +44 (0)1923 691865

 +44 (0) 1923 691 800
 +44 (0) 1923 691 888
 service@tsc-europe.com



Benelux BV

Randstad 22-123
1316 BW Almere
The Netherlands
www.optoma.nl

 +31 (0) 36 820 0252
 +31 (0) 36 548 9052



France

Bâtiment E
81-83 avenue Edouard Vaillant
92100 Boulogne Billancourt, France

 +33 1 41 46 12 20
 +33 1 41 46 94 35
 savoptoma@optoma.fr



Spain

C/ José Hierro,36 Of. 1C
28522 Rivas VaciaMadrid,
Spain

 +34 91 499 06 06
 +34 91 670 08 32



Deutschland

Wiesenstrasse 21 W
D40549 Düsseldorf,
Germany

 +49 (0) 211 506 6670
 +49 (0) 211 506 66799
 info@optoma.de

Scandinavia



Lerpeveien 25
3040 Drammen
Norway

 +47 32 98 89 90
 +47 32 98 89 99
 info@optoma.no

PO.BOX 9515
3038 Drammen
Norway

Korea

WOOMI TECH.CO.,LTD.
4F, Minu Bldg.33-14, Kangnam-Ku,
Seoul,135-815, KOREA
korea.optoma.com

 +82+2+34430004
 +82+2+34430005



Japan

東京都足立区綾瀬3-25-18
株式会社オーエス
コンタクトセンター:0120-380-495

 info@os-worldwide.com
www.os-worldwide.com



Taiwan

12F., No.213, Sec. 3, Beixin Rd.,
Xindian Dist., New Taipei City 231,
Taiwan, R.O.C.
www.optoma.com.tw

 +886-2-8911-8600
 +886-2-8911-6550
 services@optoma.com.tw
asia.optoma.com



Hong Kong

Unit A, 27/F Dragon Centre,
79 Wing Hong Street,
Cheung Sha Wan,
Kowloon, Hong Kong

 +852-2396-8968
 +852-2370-1222
www.optoma.com.hk

China

5F, No. 1205, Kaixuan Rd.,
Changning District
Shanghai, 200052, China

 +86-21-62947376
 +86-21-62947375
www.optoma.com.cn



P/N:36.7CM08G001-A