

FHDQ130

Fully optimised 130" all-in-one (AIO) QUAD LED display



Operation Manual

**2019.11
Document version 1.70**

TABLE OF CONTENTS

Important Safety Notice	4
Installation/Use Precautions of AIO Products	5
Accessories Supplied	6
Spare Parts	7
Parts and Functions	8
Interface Specifications	8
Remote Controller	9
Assembly	10
Component Placement	10
Intelligent Modules	11
Installation	12
Floor Stand	12
Wall Mount	13
Hanging	15
How to Mount and Dismount Intelligent Module	16
How to Assemble the Main Body	18
How to Split the Main Body into two parts	21
Packaging	24
Electrical	25
Circuit protection	25
Earth leakage considerations	25
Inrush-current and over-current considerations	25
Earthing	25
FCC Statement	25
EMC Statement	25
AC Power	26
DC Power	26
Settings	27
Software Installation	27
Software Settings	29
USB/WIFI/LAN Connection Settings	32
Basic Settings	42
Program Editing	44
Main Toolbar	44
Right-Click Menu of the Play Page	44
Program Edit Toolbar	45
Play File of Program	45

Program Structure	45
Program Page	46
Program Window	47
Program Edit Process	48
Async Content Editing	48
Publish Programs through USB/WIFI/LAN	49
Publish Programs through USB disk	49
Sync Playing	51
Network and Management	52
Connection and Management	52
Add Group and Device	52
APP Operation Instructions	53
System Overview	53
APP Installation Instructions	53
APP Operating Instructions	53
Search Terminals	54
Terminal Control	54
Edit Program	56
Version Information	58
Appendix	59
A Specifications	59
B Procedure for Intelligent Module Replacement	61
C Troubleshooting Guide	61
D Mechanical Assembly	62
E RS232 Commands	64
F WiFi Hotspot SSID and Password	64

Important Safety Notice

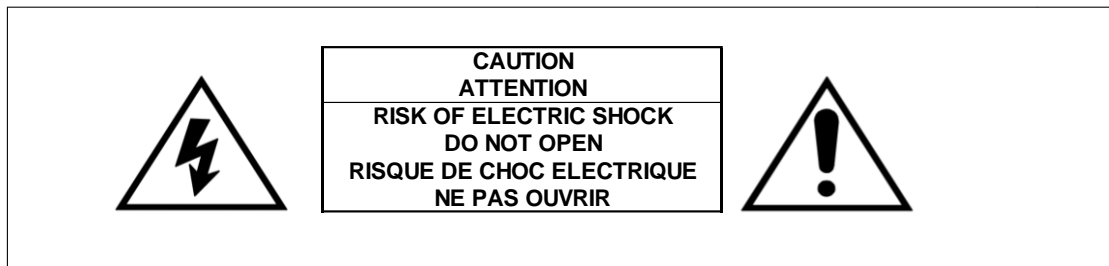

- Always ensure that the unit is properly earthed and power connections correctly made.
- This equipment must be supplied from a power system providing a protective earth connection and having a neutral connection, which can be reliably identified.
- The power outlet supplying power to the unit should be close to the unit and easily accessible.
- Ensure whole system power off before connect or disconnect the network cable.
- Do not handle the power supply plug with wet hands.
- Do not place the display on sloped or unstable surfaces, otherwise it may fall off or tip over.
- Do not place any objects on top of the display.
- No naked flame sources, such as lighted candles.
- To prevent electric shock , do not remove cover.
- No user serviceable parts inside. Refer servicing to qualified service personnel.
- Don't grab the four corners of display (after finishing assembling) when you want to move it from the floor, or the display will become deformed and affect the alignment. You need to erect it up and move it.
- Don't grab any sheet metal of the display when you assemble the display, otherwise the sheet metal will become deformed and affect the flatness .You can only catch the reinforcing rib.

Installation/Use Precautions of FHDQ130 Products

The interior design of FHDQ130 LED display screen is very sophisticated, but it basically has no dustproof/waterproof capability, please follow the following precautions during installation and use.

1) Screen storage/working environment requirements

Storage temperature : -10~50°C ; Relative humidity : 10%~60%;

Working temperature : 0~40°C ; Relative humidity : 10%~60%.

2) Installation requirements

When looking to install an AIO please ensure that suitable area is located avoiding places of high condensation and humidity(must be less than 60%non-condensation state). It is recommended to install dehumidifier in the environment to control humidity.

3) Cleaning requirements









During the use of the screen, if there is any accumulation of dust on the surface, it is necessary to use anti-static soft bristle brush or dust-free cloth to clean the screen. Please be careful in the cleaning process to avoid bumping and damaging the LED. Do not use a damp cloth to scrub the screen.

4) Usage requirements



The LED screen is recommended to be turned on frequently. For the display screen or module that has been stored for more than 3 days (including), the method of gradually increasing brightness should be adopted to remove accumulated moisture by slowly heating, so as to avoid the abnormal quality such as dimming and dead lights caused by expansion of moisture or moisture and electronic migration in the LED lamp during instantaneous high temperature.

Accessories Supplied

Item	Description	Photo	Qty.
1	AC Power Cable 14S-OGE16A-PZ-PF		1
2	AC Power Cable 14S-OUL20A-PZ-PF		1
3	AC Power Cable 14S-OBS13A-PZ-PF(Assembled)		1
4	M10 Large-headed Screw 600-W32M10-20-PF		10
5	Magnetic Tool 420-MAG130-A7-PF		1
6	M4x10 Flat Head Screw 600-FM0410-DC-PF		24
7	M10X16 Screw 600-HM1015-S0-PF		12
8	M8x60 Expansion Screw 600- FM0860-10-PF		32
9	M4x10 Screw(with plain and spring washer) 60S-WM0409-DC-PF		11
10	M10 Flat Washer 630-102302-S0-PF		12
11	M10 Spring Washer 631-101526-S0-PF		12
12	M4x12mm Screw 60S-WM0412-S0-PF		8
13	Hang Plate 420-TV1212-1A-PF		2
14	Mounting Plate 420-TV1212-21-PF		2

15	Mounting Brace 420-TV1212-31-PF		1
16	USB Flash Disk 333-DISK8G-00-PF		1
17	Screwdriver 690-A25SDR-10-PF		1
18	T-Hand Hex Key 690-DEM050-1A-PF		1
19	Screwdriver 690-A15PBT-10-PF		1
20	Infrared Remote Controller 898-IRC001-00-PF		1
21	WIFI Dongle 898-00WUSB-00-PF		1
22	Anti-static Gloves 690-ASHAND-20-PF		4
23	Cordless Anti-static Wristband 690-ASWA15-00-PF		4
24	EPE FOAM 540-A130BT-10/20-PF		4+1
25	Accessories Check List		1

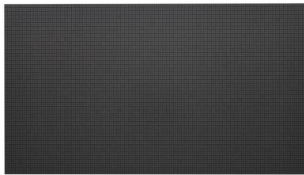
Spare Parts

Item	Description	Photo	Qty.
1	Intelligent Module 0-AM4-01G090FFEA-02P		3
2	M4x10 Flat Head Screw 600-FM0410-DC-PF		24
3	M4x10 Screw(with plain and spring washer) 60S-WM0409-DC-PF		11

Parts and Functions

◆ Interface Specifications

Access	SPECIFICATIONS
HDBaseT input	Qty : 1
LAN	Qty : 1 Panel Control: Telnet
3G-SDI	Qty : 1
RS232	Qty : 1 Purpose : External Control (AMX)
VGA input	Qty : 1 Analog
Audio Output	Qty : 1 / stereo output 1/8" (3.5mm)TRS
HDMI input	Qty : 2 HDMI : 1.4a
USB 3.0	Qty : 1 Purpose : Provide 5V Power or Image Processor FW upgrade only
USB 2.0	Qty : 2 Purpose : support external USB disc storage (128G in maximum) or communication equipment or wifi dongle
USB Type B	Qty : 1 Purpose : (Service use)
Button	4 keys. Power on / Source/ Brightness + / Brightness -
LED indicator	Solid red = Standby Blinking green = Warm up Solid green = Normal operation Blink green / red alternately = Transfer / update data Fast blinking green = Remove USB Fast blinking green / red = Firmware update

Remote Controller

	Function	Description
Power	Power	Power
PIP Source	PIP Source	Switch PIP Source
PIP position	PIP Position	Counter Clockwise Picture in Picture Position
PIP size	PIP Size	Increase/Decrease 30%, 40%, 50% (Default)
KEY 1	Media Player	Switch to Media Player
KEY 2	Brightness +	Brightness Increase
KEY 3	Volume -	Audio Volume Decrease
KEY 4	Volume +	Audio Volume Increase
KEY 5	Brightness -	Brightness Decrease
PIP on/off	PIP ON/OFF	Picture in Picture ON/OFF
KEY 6	HDMI 1	Switch to HDMI 1 Source
KEY 7	HDMI 2	Switch to HDMI 2 Source
KEY 8	VGA	Switch to VGA Source
KEY 9	3G-SDI	Switch to 3G-SDI
KEY 10	HDBaseT	Switch to HDBaseT

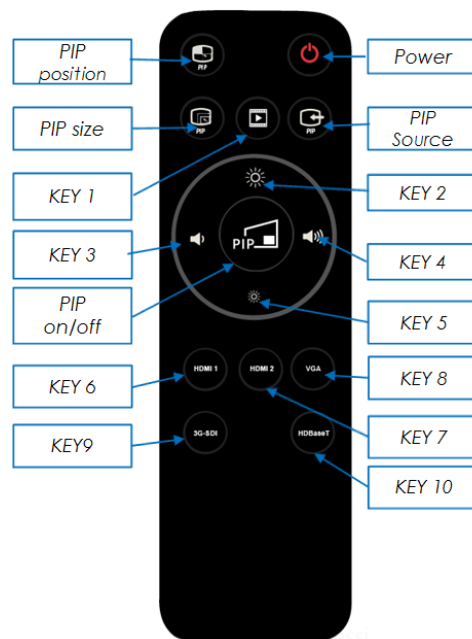

Assembly

Each FHDQ130 LED display is designed to be mounted with a specific fixing structure. Please refer to the Mechanical Assembly (**Appendix E**) for the detail dimensions.

The list in table 1 is the main components of an FHDQ130 LED display. The intelligent modules are mounted to the front surface and the other main component locations are shown in Figure 1.

Item	Description	Qty
1	Intelligent Module	144
2	IR Receiver Board	1
3	Power and Mini Card Convertor Board(2in1)	72
4	Signal Control Board	1
5	Main Power Board	1
6	PV7 Board	1
7	System Control Board	1
8	System Core Board	72
9	4.2V /189W Switched Mode Power Supply	24
10	12V /200W Switched Mode Power Supply	1
11	EMI Filter	1

Note: The PSU output is adjustable, the actual value would subject to the label of manufacturing data

Table 1 - Major components of FHDQ130 LED display

◆ Component Placement

There are seven kinds of system board worked for the LED display, IR Receiver Board, Power and Mini Card Convertor Board, Signal Control Board, Main Power Board, PV7 Board ,System Control Board and System Core Board. Please refer to the description for each board in the follow sections.

FHDQ130 LED display is combined with intelligent module and case. The intelligent modules and case are fixed by magnetic structure.

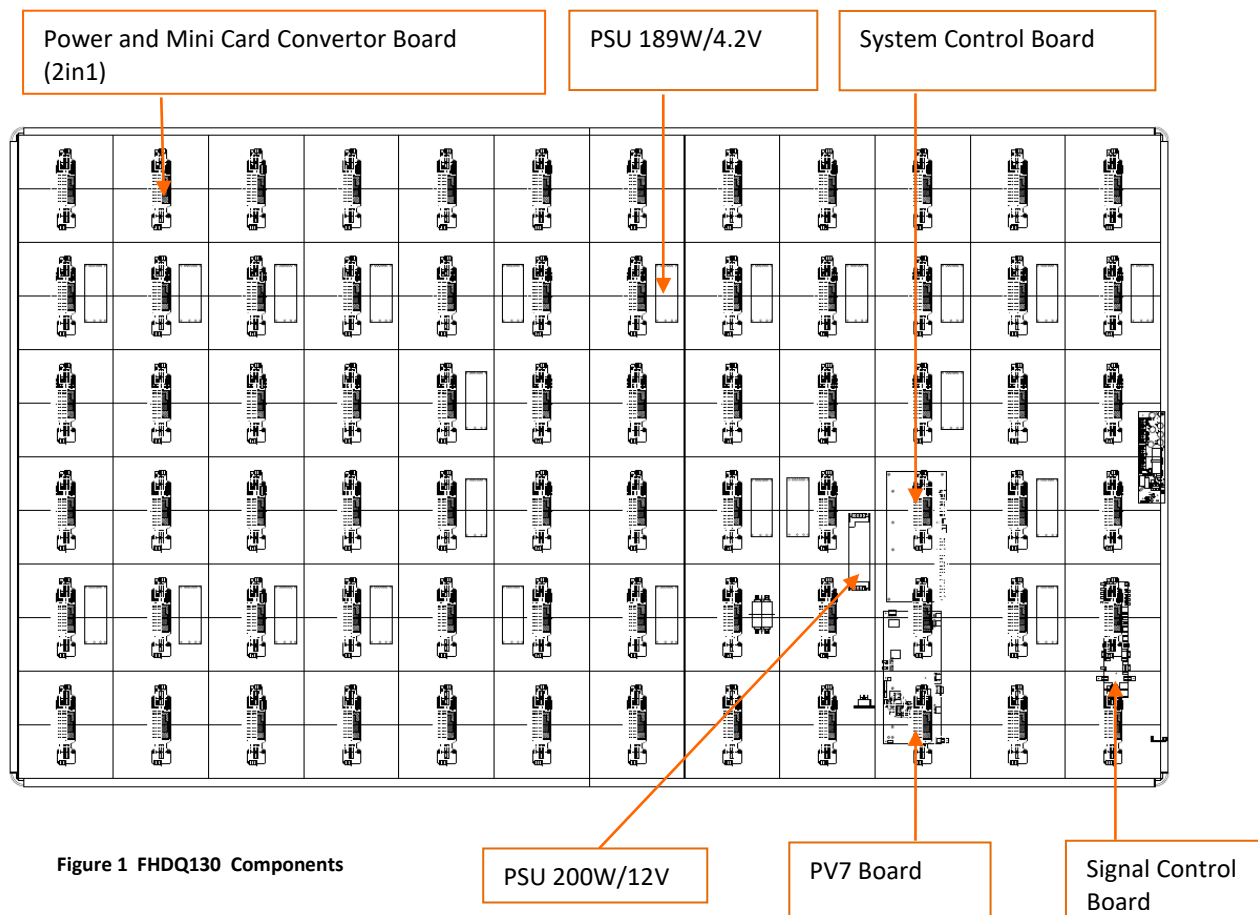

Figure 1 FHDQ130 Components

◆ **Intelligent Modules**

The front face of the FHDQ130 LED display is fitted with 144 light emitting diode (LED) dot matrix modules known as Intelligent Modules. Each intelligent module is fitted with 14400 LEDs* plus associated drive electronics. Electrical connections (low voltage power, and digital data) are made to the rear of each intelligent module, from inside of the enclosure.

Figures 2 and 3 are showing the front and rear views of an FHDQ130 intelligent module. For procedure of intelligent module replacement, please refer to **Appendix B**.

** Remark: each intelligent module contains 160x90 pixels (row x column) and each pixel is composed by 3 in 1 LEDs, so there are totally 14400 LEDs fitted on the front face of an intelligent module.*

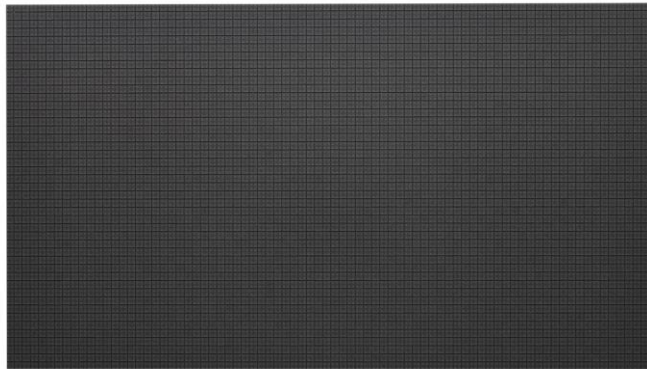

Figure 2 Intelligent Modules - front view

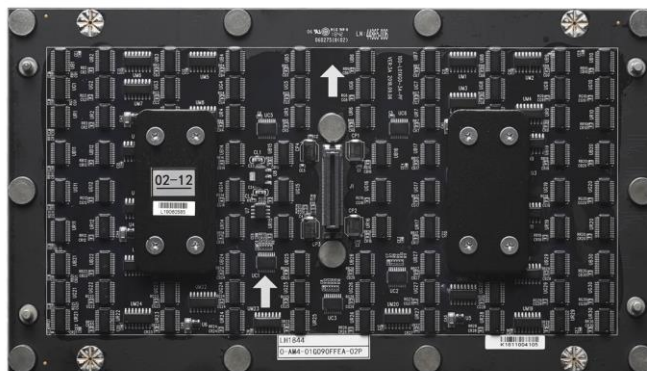

Figure 3 Intelligent Module - rear view

Installation

The FHDQ130 LED display, each intelligent module is equipped with 4 pcs guide pin, are fixed with magnetic structure and jointed together both vertically and horizontally, so that they can form one surface of screen-configuration.

The FHDQ130 LED display is designed to be mounted on the stand (sold separately), on the wall or hanged (wall and hanging brackets included). When installing, it is important to ensure that the entire screen is correctly aligned, both vertically and horizontally.

◆ Floor Stand

Step1. Assemble the floor stand.

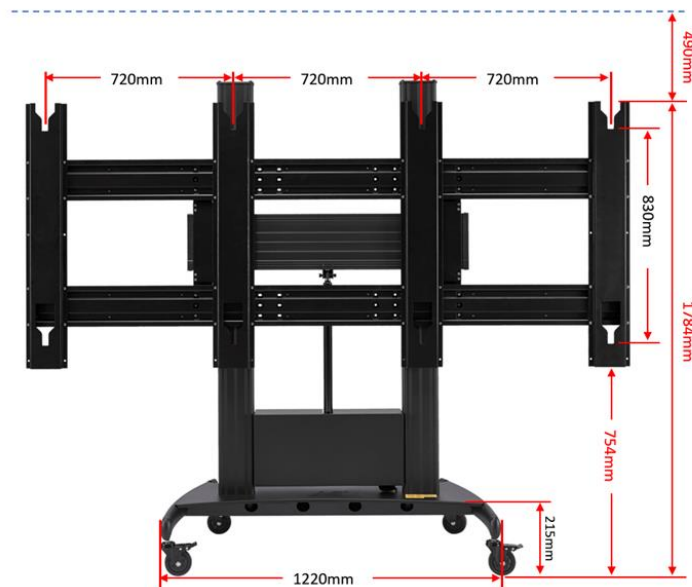

Step2. Please use torque wrench to install 8 pcs M10 large-headed screws to the back side of display. The torque for these screws is 1.2Nm. Or you can use your hands to tighten them up, just make sure the screws are well installed.



Step3. Mount the display to the floor stand.

◆ Wall Mount

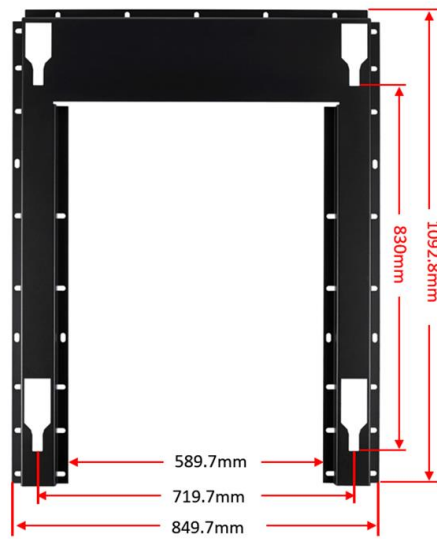

Mounting Plate

Step1. Use 4 pcs M4x12 screws to install one side of the mounting brace to one mounting plate. Then install the mounting brace to another mounting plate.

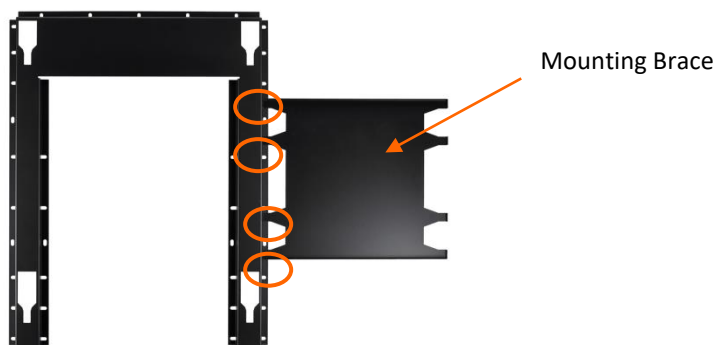

M4x12mm Screw

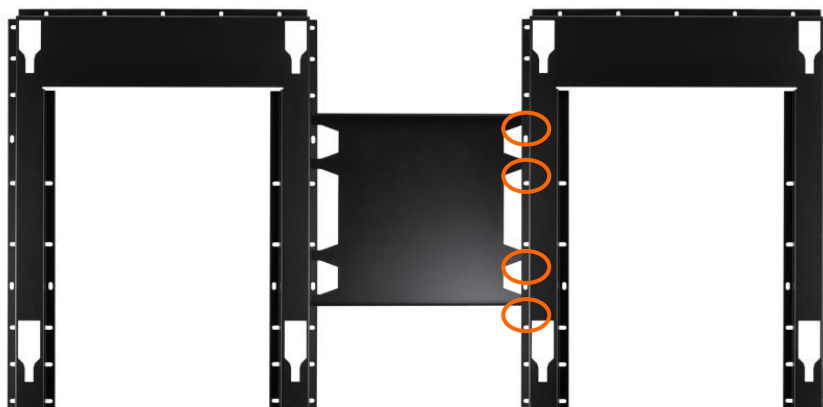

Step2. Drill 30 pcs 10mm mounting holes (60-65mm depth) on the wall and install 2 pcs mounting plates with 30 pcs M8 x60 stainless steel expansion screws to the wall.

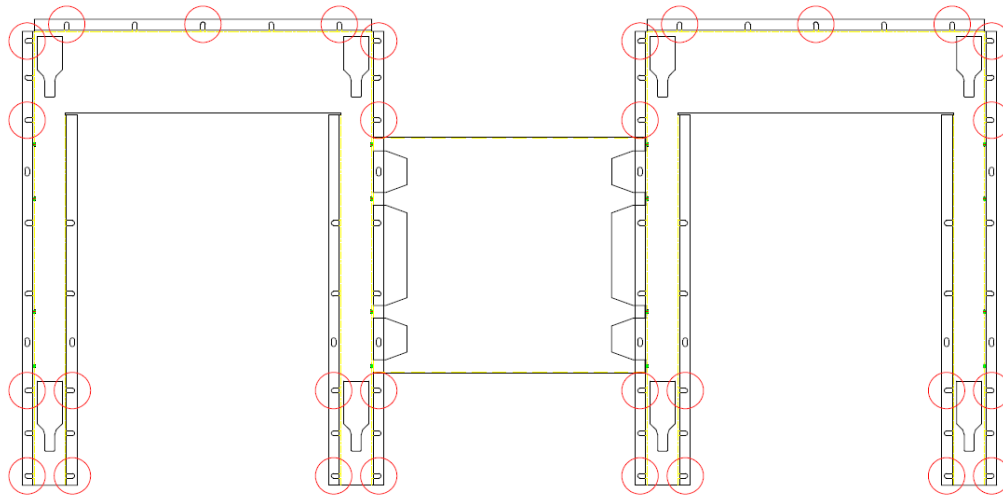
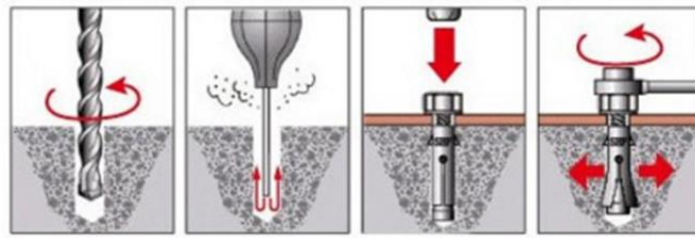

Step3. After installing the mounting plates ,hang on the LED Display.

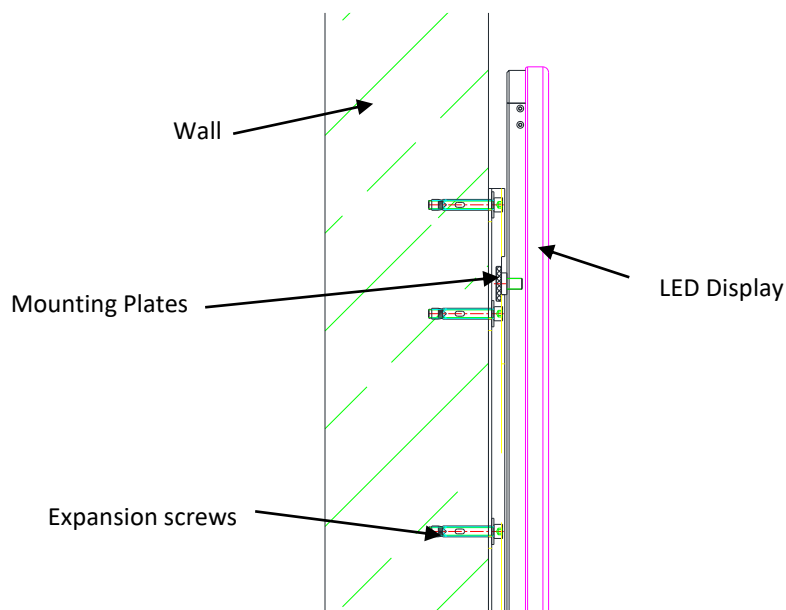

◆ Hanging

Step1. Install 12pcs M10X16 screws(with a spring washer and flat washer) to the back side of LED display.



M10X16 Screw



M10 Flat Washer



M10 Spring Washer

Step2. Hang the LED display. If there is a crane, hang the LED display with the help of the crane.

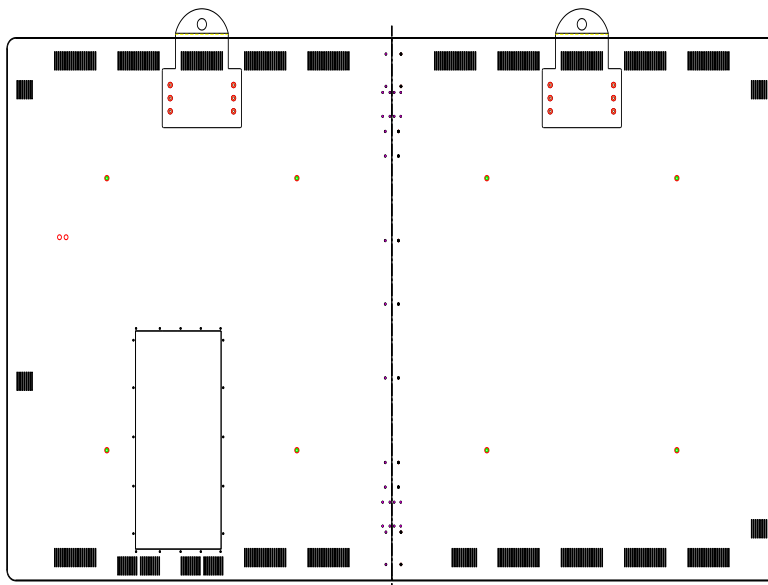

◆ **How to Mount and Dismount Intelligent Module**

The FHDQ130 LED display is designed for maintenance front access, When the intelligent module malfunction; please replace it by the following procedure.

- Note:1. Install the modules after the display is assembled, cut off the power.**
- 2 we recommend that you should pay much attention to protect the LEDs when you maintain the intelligent module. Please operate with anti-static gloves.**
- 3. Please ensure the magnetic tool is used correctly.**
- 4. Please pay attention to the arrow direction on the back side of the modules.**



Dismount Intelligent Module

Step 1. Power off the LED display.

Step 2. Hold the 2pcs handles, push the lock inward and pull the right handle toward outside, and then take it up.

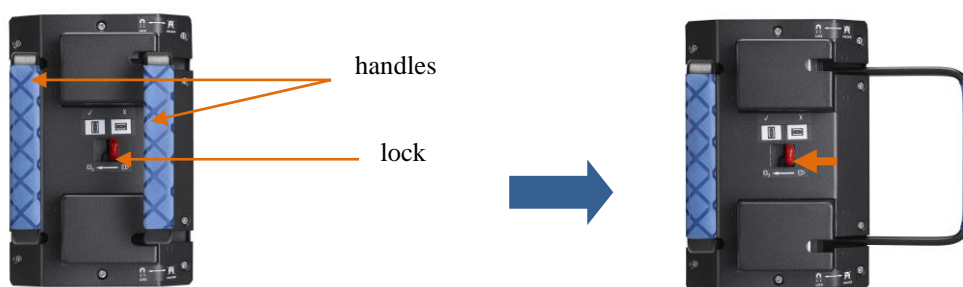

Step 3. Take the tool up and horizontally fit it closely to the display surface. Please pay more attention to the direction.



Step 4. Pull the right handle towards the center.



Step 5. Ensure the magnet is locked. Detach the tile carefully.



Step 6. Put down the intelligent module and tool together carefully onto an EPE (or other soft pad).

Step 7. Push the lock toward inside and pull the right handle toward outside and lift the tool up carefully.

Mount Intelligent Module

1. Take out a spare intelligent module and locate the intelligent module to case, please pay attention to the arrow direction on the back side of it.

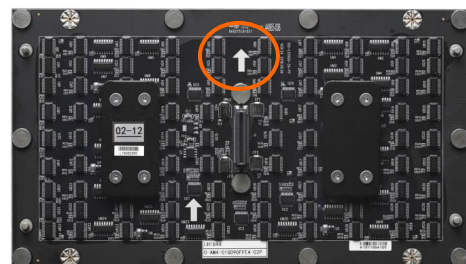

2. Apply pressure to the intelligent module.



Note: When mounting an intelligent module back, pay more attention to the guide pin which is located in corners to mount it smoothly.

◆ **How to Assemble the Main Body**

The main body of display is split into two pieces, and all the accessories are attached to each part before shipping. Please follow below procedures to assembly two parts into a whole display.

Note: 1. Don't grab the four corners of display (after finishing assembling) when you want to move it from the floor, or the display will become deformed and affect the alignment. You need to erect it up and move it.

2. Don't grab any sheet metal of the display when you assemble the display, otherwise the sheet metal will become deformed and affect the flatness. You can only catch the reinforced rib.

3. Before assembling the display, you need to plug the AC power cable first. There are three AC power cables provided, Euro plug, UK plug and US plug. Please use the screwdriver provided to loosen the screw circled below and take out the cover. Then you can plug the AC power cable.

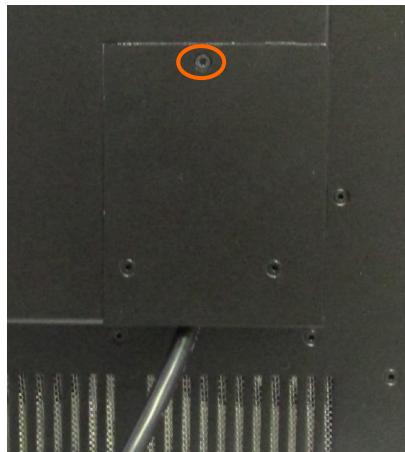

Step 1. Take out each part of the display and put them on the floor, please make sure all the parts are well protected.



Left

Right

Step 2. Move two parts to each other, when the gap is minimal, lock the side-locks counterclockwise, you will feel the resistance when the side-locks are in place. (There are two side-locks for each panel)

Note: Before locking the side-locks, you need to loosen the side-locks clockwise in place firstly.

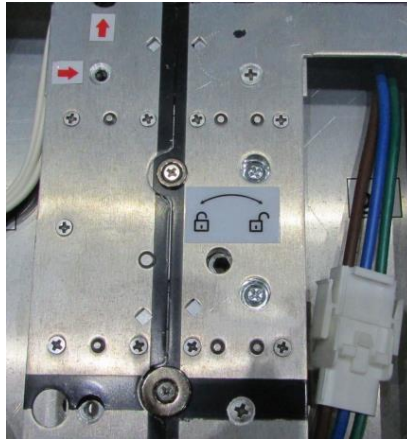

Step3. Install 12 pcs M4 flat head screws.

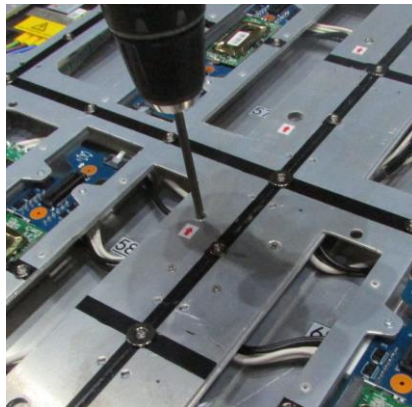

Step4. Install 11 pcs M4 button head cap screws(with a plain washer and spring washer).



Step 5. Install and tighten 3 pcs black M4 flat head screws to both upper and lower side of the case.

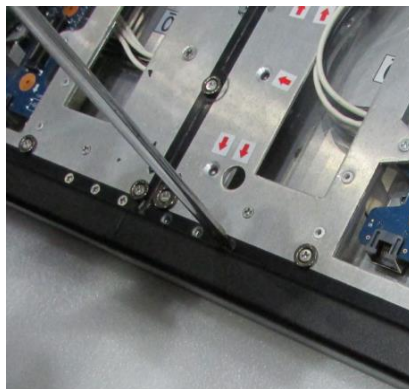

Step 6. Install and tighten 3 pcs black M4 flat head screws to both top and bottom side of the case.

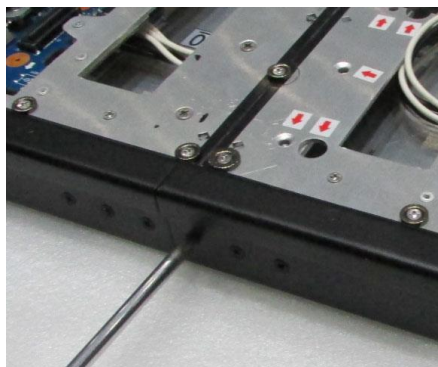

Step 7. After assembling the main body , you need to connect all the cables and install back all the intelligent modules.
Please refer to 'How to dismount intelligent module' for details.

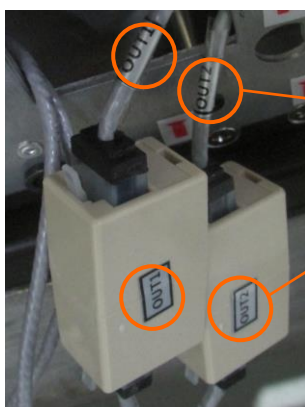

Please pay attention to the labels , eg. RJ45 cable labelled OUT1 is matched to connector labelled OUT1.

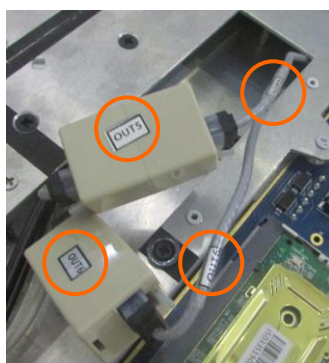

Step 8. All the intelligent modules have labels stuck on the back side. Please follow below number to install back the intelligent modules.

We recommend that all the intelligent modules are installed to the corresponding position on case ,or the screen will show color difference. Also, there is a serial number at the left bottom of frame which match to the one on the back side of intelligent modules and spares.

01-01	01-02	01-03	01-04	01-05	01-06	01-07	01-08	01-09	01-10	01-11	01-12
02-01	02-02	02-03	02-04	02-05	02-06	02-07	02-08	02-09	02-10	02-11	02-12
03-01	03-02	03-03	03-04	03-05	03-06	03-07	03-08	03-09	03-10	03-11	03-12
04-01	04-02	04-03	04-04	04-05	04-06	04-07	04-08	04-09	04-10	04-11	04-12
05-01	05-02	05-03	05-04	05-05	05-06	05-07	05-08	05-09	05-10	05-11	05-12
06-01	06-02	06-03	06-04	06-05	06-06	06-07	06-08	06-09	06-10	06-11	06-12
07-01	07-02	07-03	07-04	07-05	07-06	07-07	07-08	07-09	07-10	07-11	07-12
08-01	08-02	08-03	08-04	08-05	08-06	08-07	08-08	08-09	08-10	08-11	08-12
09-01	09-02	09-03	09-04	09-05	09-06	09-07	09-08	09-09	09-10	09-11	09-12
10-01	10-02	10-03	10-04	10-05	10-06	10-07	10-08	10-09	10-10	10-11	10-12
11-01	11-02	11-03	11-04	11-05	11-06	11-07	11-08	11-09	11-10	11-11	11-12
12-01	12-02	12-03	12-04	12-05	12-06	12-07	12-08	12-09	12-10	12-11	12-12

Front View

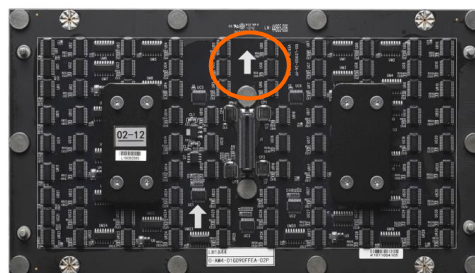

◆ **How to Split the Main Body into two parts**

Step 1 .Take down all the intelligent modules and put them onto an EPE (or other soft pad).



Step 2. Loosening 3pcs black M3 flat head screws from both upper and lower sides of panel.

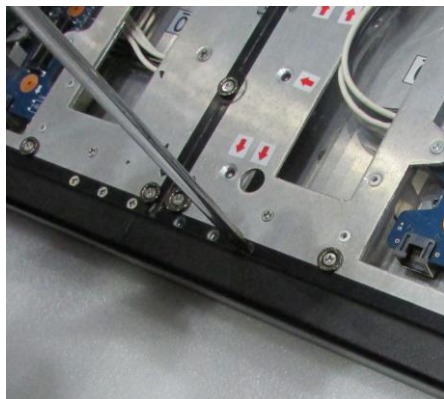

Step 3. Loosening 3pcs black M3 flat head screws from both top and bottom sides of panel.

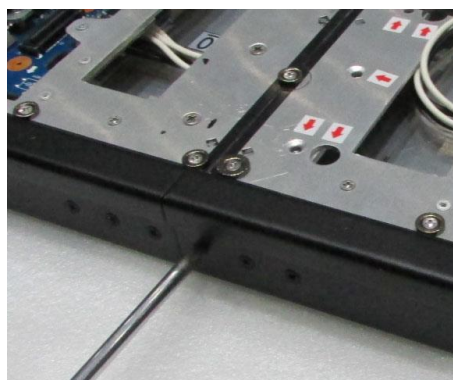

Step 4. Disconnect all the cables which used to connect the left and right part.



Power cable

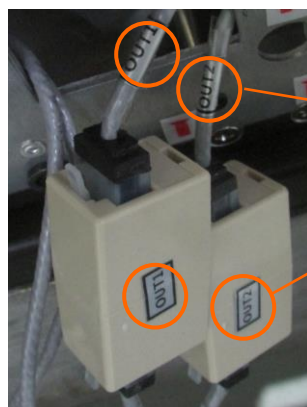

When disassembling ensure that you disconnect RJ45 and power cable accordingly.

Step 5. Rotate side-locks clockwise to loosen.

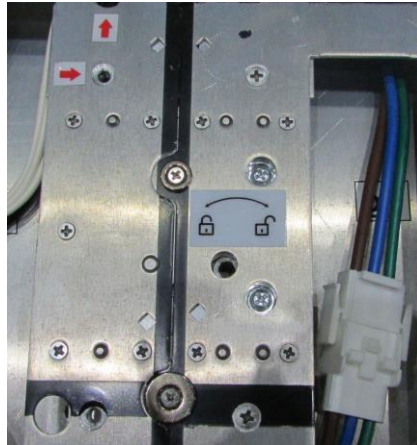

Step6. Loosening 12 pcs M4 flat head screws.

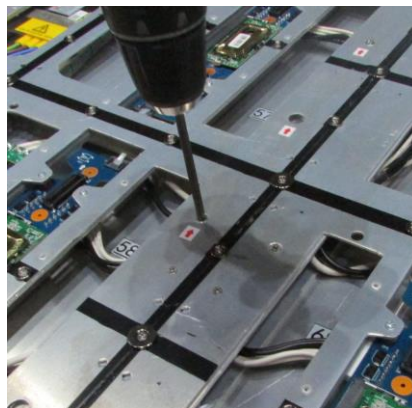

Step7. Loosening 11 pcs black M4 button head cap screws(with a plain washer and spring washer).



Step 8. Holding the reinforced rib and disassemble the display.

◆ Packaging



Flight Case

1. Put all intelligent modules into antistatic bags separately and set them into the flight case.



2. Take out an PE bag and put one part of display into the bag. Seal the bag. Use the same method to package the other part of display.

3. Put these two parts into the flight case next to the intelligent modules.



Electrical

The power distribution system used must provide adequate protection against excess line current and leakage currents to earth.

Electrical Characteristics for ONE FHDQ130							
At 200V AC Input				At 240V AC Input			
Parameter	Unit	Rating nom.	Max.	Parameter	Unit	Rating nom.	Max.
Input current	A	6.00	15.00	Input current	A	5.00	12.50
Input freq.	Hz	50 – 60	65	Input freq.	Hz	50 – 60	65
Power	VA	1200	3000	Power	VA	1200	3000

◆ Circuit Protection

Each section of the screen should be protected by a Circuit Breaker to protect against high fault currents, and a Residual Current Device (RCD) to detect earth leakage currents.

◆ Earth Leakage Considerations

Each FHDQ130 LED display has earth leakage current contributions from twenty-five switched-mode power supplies and two filters. The total earth leakage current per LED display can be up to 25.35mA at 240V. If a 30mA RCD is used, then the maximum number of LED displays per section should be safely limited to 1.

◆ Inrush-current and over-current considerations

The inrush current of the switched mode power supplies used to provide LED and logic power to each LED display is specified by the manufacturer as 15-20A at 240volts for a duration of 3mS. However, maximum current in the steady-state for a LED display is considerably less: 12.50A at 240 volts and 15.00A at 200 volts. The circuit breaker used to control a section of the screen must be able to handle the short-term inrush current at switch-on, without causing unnecessary disconnection of the supply, and be able to detect excess currents due to faults within the equipment, during normal operation. 20A Circuit Breaker is recommended.

◆ Earthing

Each LED display is separately connected to the AC power distribution system's earth through green/yellow wires connection. All exposed metalwork is also connected to this earth.

◆ FCC Statement

This equipment has been tested and found to comply with the limits for a Class A digital device, pursuant to Part 15 of the FCC Rules. These limits are designed to provide reasonable protection against harmful interference when the equipment is operated in a commercial environment. This equipment generates, uses, and can radiate radio frequency energy and, if not installed and used in accordance with the instruction manual, may cause harmful interference to radio communications. Operation of this equipment in a residential area is likely to cause harmful interference in which case the user will be required to correct the interference at his own expense.

*Note: Modifications not authorized by the manufacturer may void users authority to operate this device.

◆ EMC Statement

Installations should be located at least 30 meters from other sensitive systems or installations and if situated in close proximity to a roadway it may create interference to vehicle radio communications.

◆ **AC Power**

The AC power cable is connected to the EMI filters and distributes to the power supply units inside the display.

Color of Wire	A.C. Supply connection (200V)	A.C. Supply connection (240V)
Brown	AC. Live	AC. Live
Blue	AC. Neutral	AC. Neutral
Green/Yellow	AC. Protective earth	AC. Protective earth

◆ **DC Power**

DC power from each power supply unit provides low voltage power to the assigned electronics components, for example, intelligent modules and driver board. The responding color of the wire represents the power connection of the relevant component, please note the list below for a clear cabling configuration.

Color of wire	D.C. Supply connection
White	Red LED / Green LED / Blue LED / TTL
Black	GND

Settings

◆ Software Installation

The software supports operating systems such as Windows XP \ Server 2003 \ Vista \ Windows 7 \ Windows 8 \ Windows10. Recommended computer configuration is:

☑ CPU 2.0 GHZ above;

☑ Memory 1 GB or more;

☑ Independent graphics card, display memory 512MB or more, and must has the DVI or HDMI output interface;

User can adjust configuration according to actual situation, mainly according to total LED screen pixels, program complexity and video whether is high-definition video source or not, etc.

1. Double click to open setup “Control Q ****.exe”, choose Installer Language (简体中文、English), click [OK].

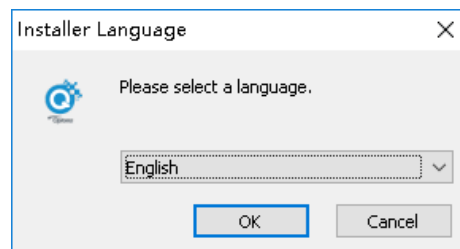

Figure 1

2. Choose the [Destination Folder], and click [Next].

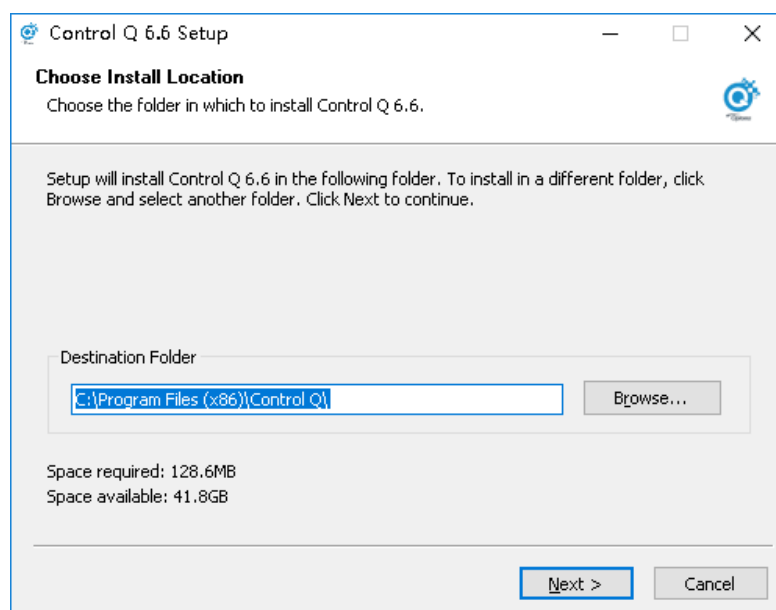

Figure 2

3. Check the components you want to install and uncheck the components you don't want to install. Click [Install] to start the installation.

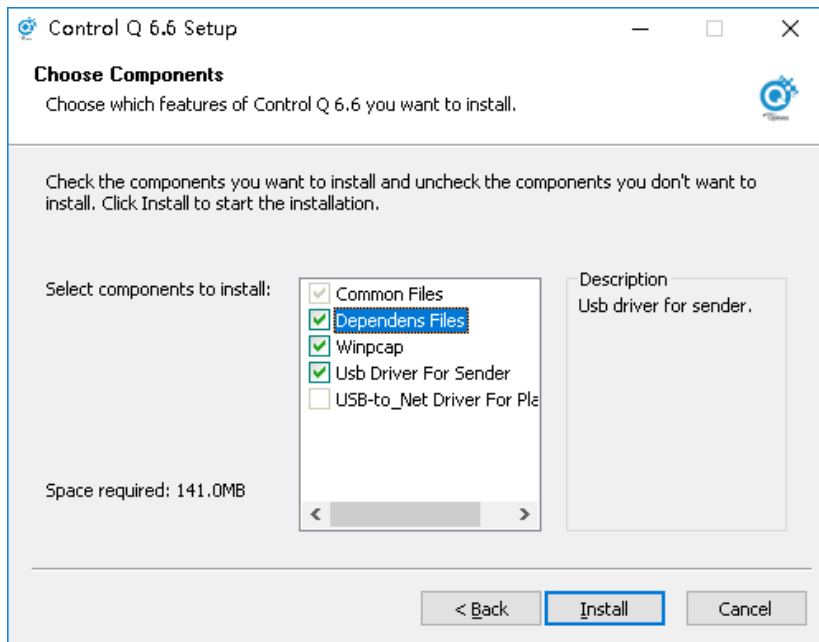

Figure 3

4. Click [Finish] when control Q has been installed on your computer.

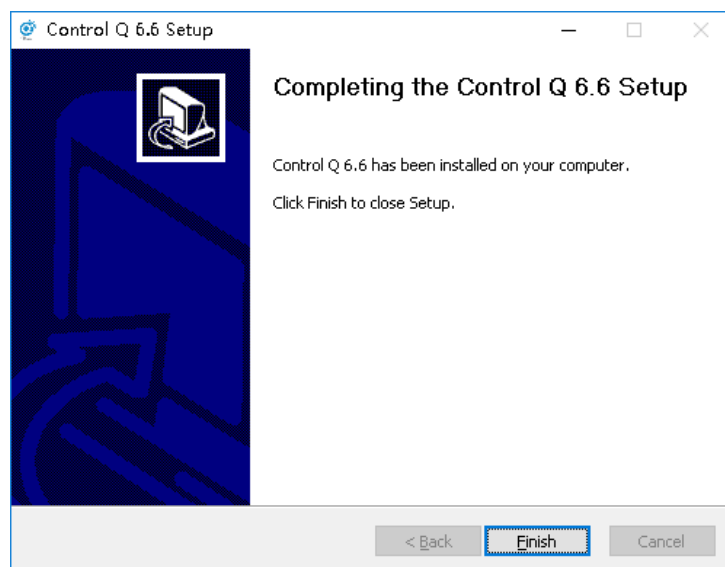

Figure 4

5. The system automatically generates desktop shortcuts, double click to open the software.

6. If you want to uninstall the software , find out the program and choose uninstall .

◆ **Software Settings**

After starting the Control Q software, you can see the software interface show as below. Include play interface (Figure 5) and main interface (Figure 6).



Figure 5

Main interface include six section: 1. Menu 2. Main Toolbar 3. Program Edit Toolbar 4. Program Public 5. Program Property 6. Status bar.

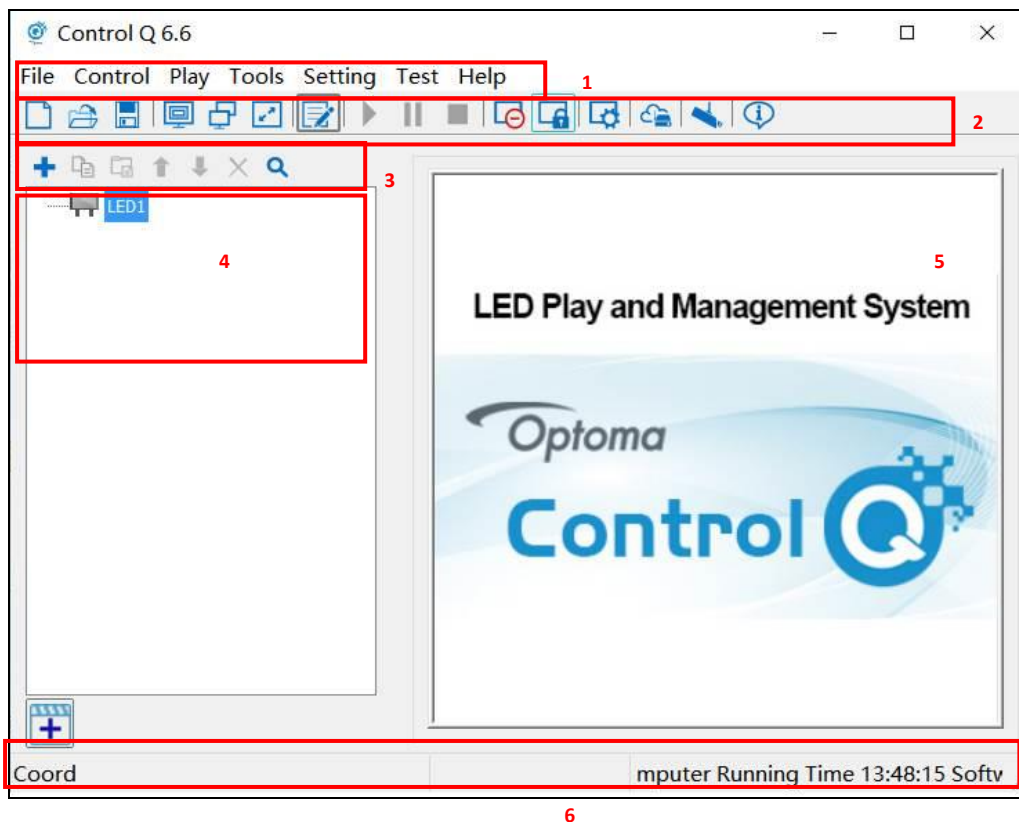

Figure 6

1. Click [Control]-[LED Screen Setting], there will show a popup window to input the password [optoma].

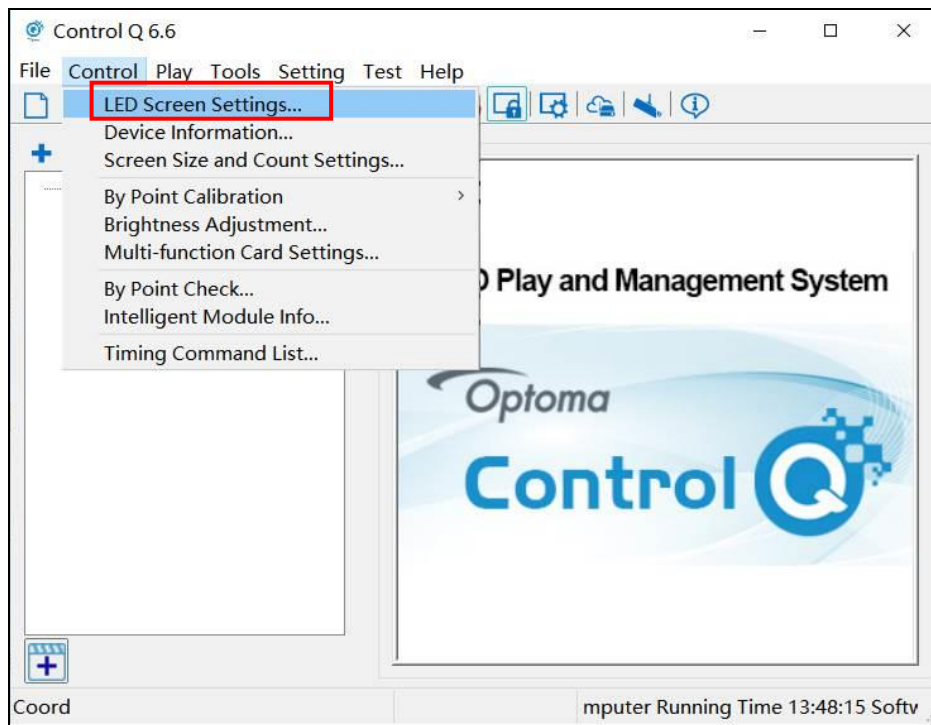

Figure 7

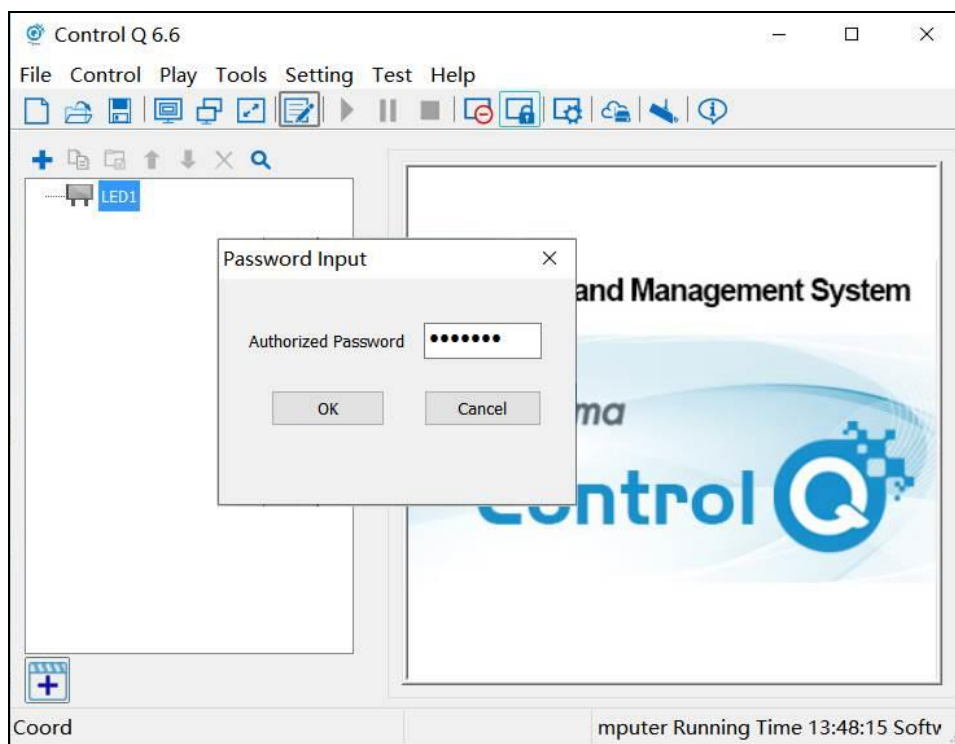

Figure 8

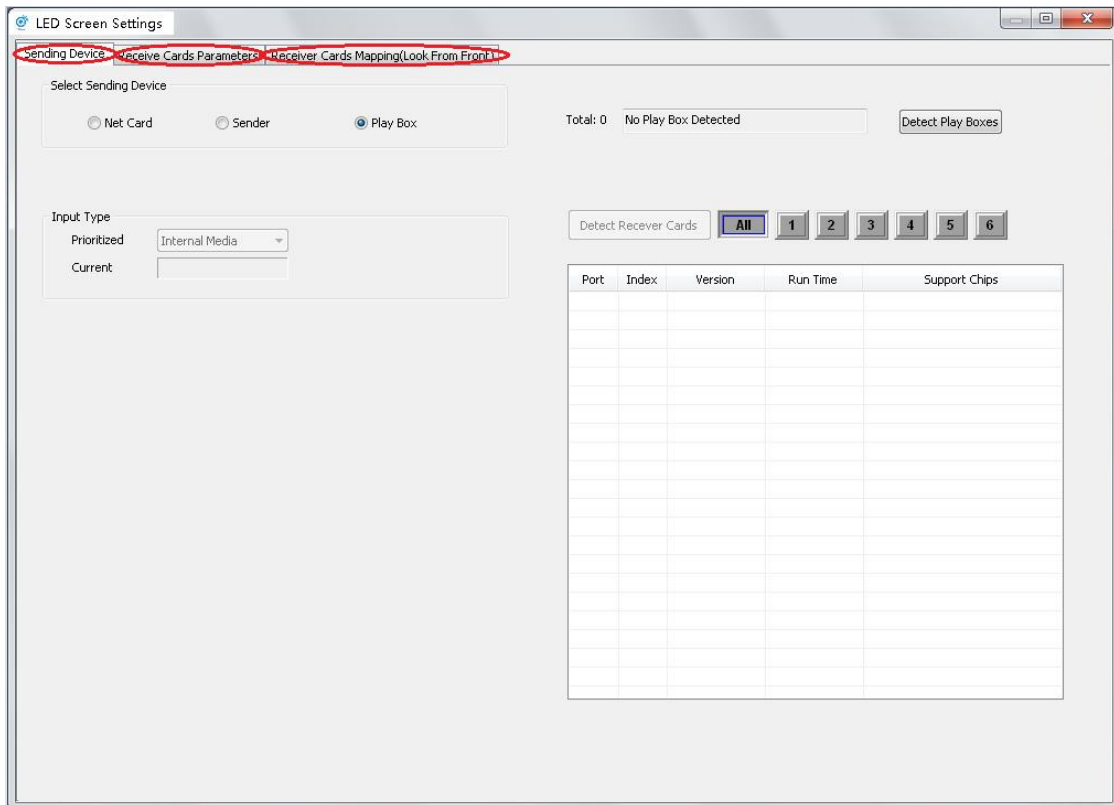



Figure 9

◆ **USB/WIFI/LAN Connection Settings**

After connecting successfully, you can send related screen parameters, upload programs, manage programs, cloud management, etc.

1. USB Connection

- (1) Power on LED display, connect your PC via USB-A to USB-C cable (Use USB-B config port on AIO QUAD)
- (2) Click the icon  to enter Program Publish interface.

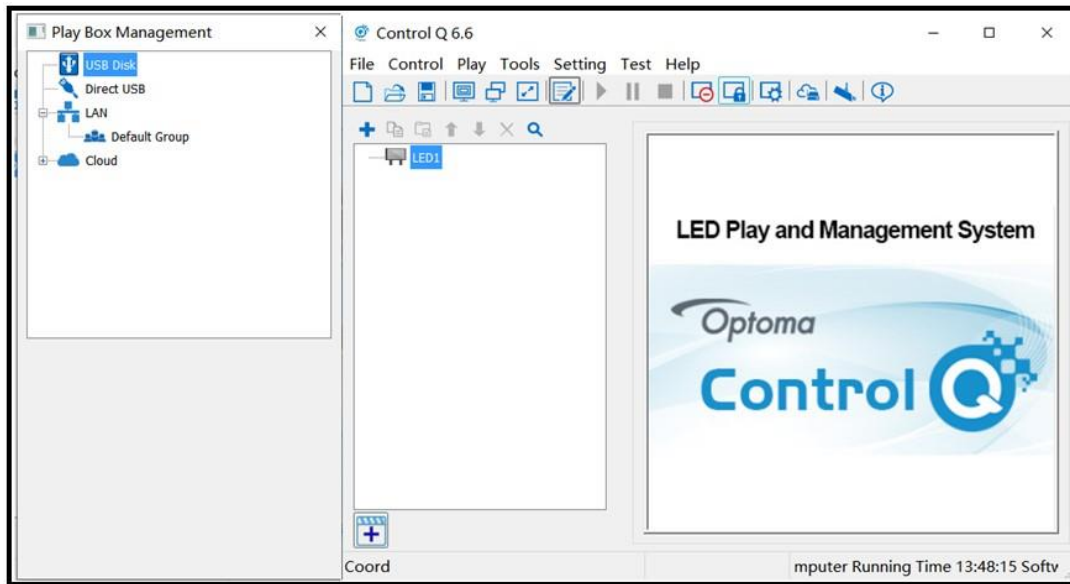

Figure 10

- (3) Left-click [Direct USB] and then right-click choose [Refresh], LED display will show up and you should set its parameters.

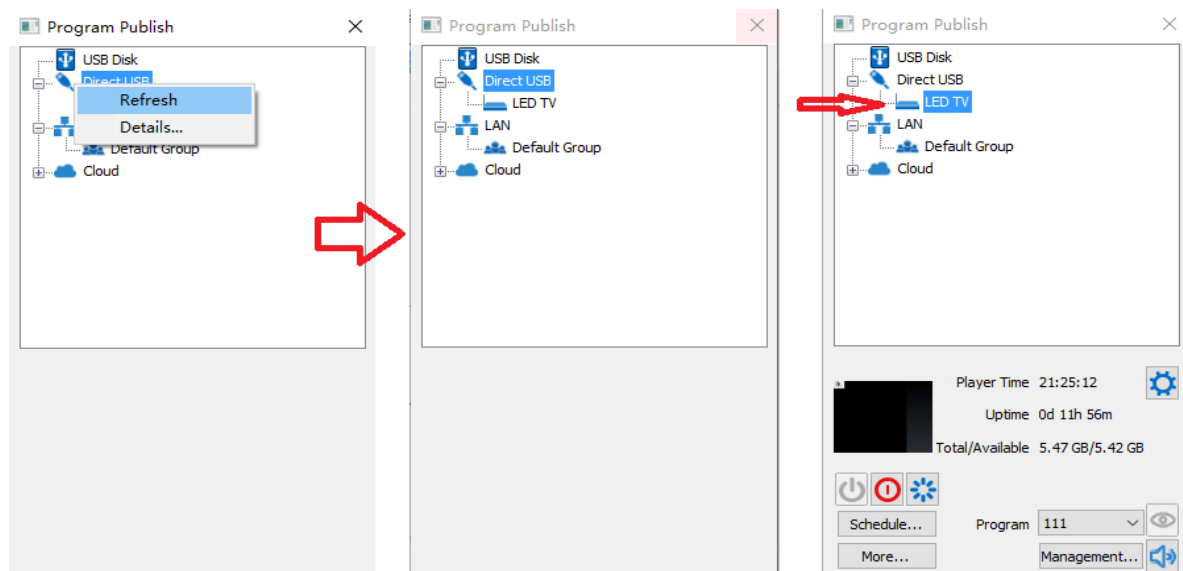

Figure 11

2. USB Disk Play Approach

There are two ways for playing the USB port media content:

Approach 1 : Plug & Play

Media content will be played automatically within alphabet order.

Approach 2: Programmed Play

1) Program needs to use Control Q to edit in advanced

2) Store program into USB

System Control Board supports the Media formats .ts .mp4 .avi .mkv .mov .bmp .jpg .png .jpeg

The media files and program are stored in the USB disk in the same time.

3) The priority of playback

- a. Plug & Play
- b. Program Play

Approach 1 : Plug & Play

Follow below step

Step 1. Put content into the root directory or \usb.files

Supported Media formats : .ts .mp4 .avi .mkv .mov .bmp .jpg .png .jpeg



Figure 12

Step 2. Use Remote controller or button to switch the signal source to internal media player

Step 3. Plug the USB disk in the USB port ,then System will play media content in alphabetical order.

Approach 2 : Programmed Play

Step 1. Insert your USB disk to the PC USB port

The USB disk should be empty before publishing for best performance. Remove previously updated programs before using it to update or play new programs and to avoid any problems.



Figure 13

Step 2. Click Control\Screen Size and Count Setting, then key in width=1920,Height=1080.

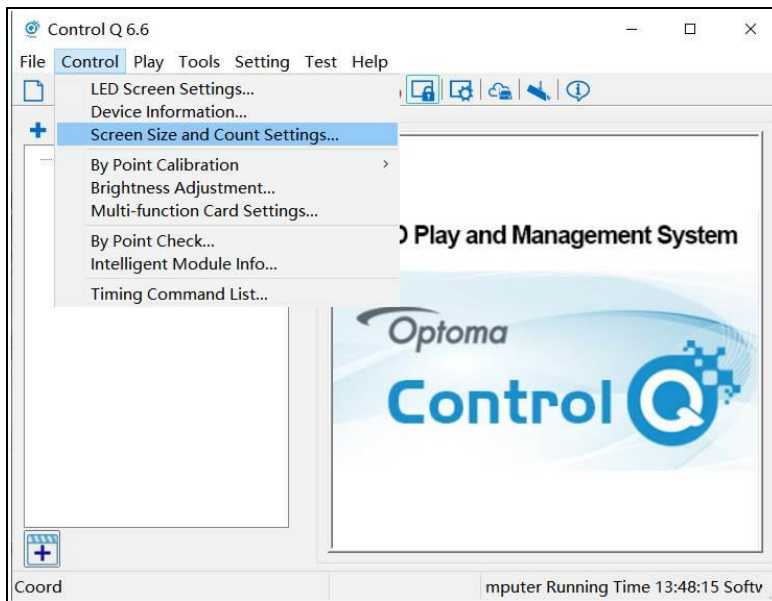

Figure 14

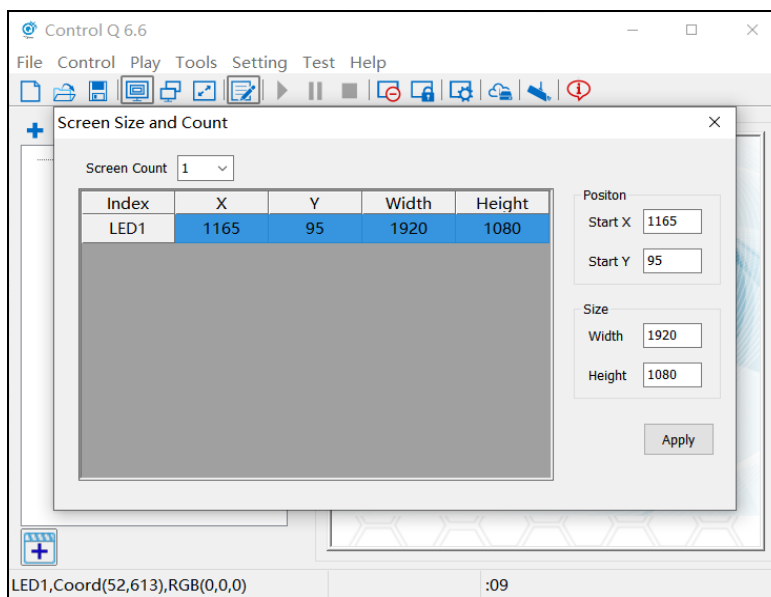

Figure 15

Step 3. Open software Control Q and click

a : Play Box Management

b : USB Disk

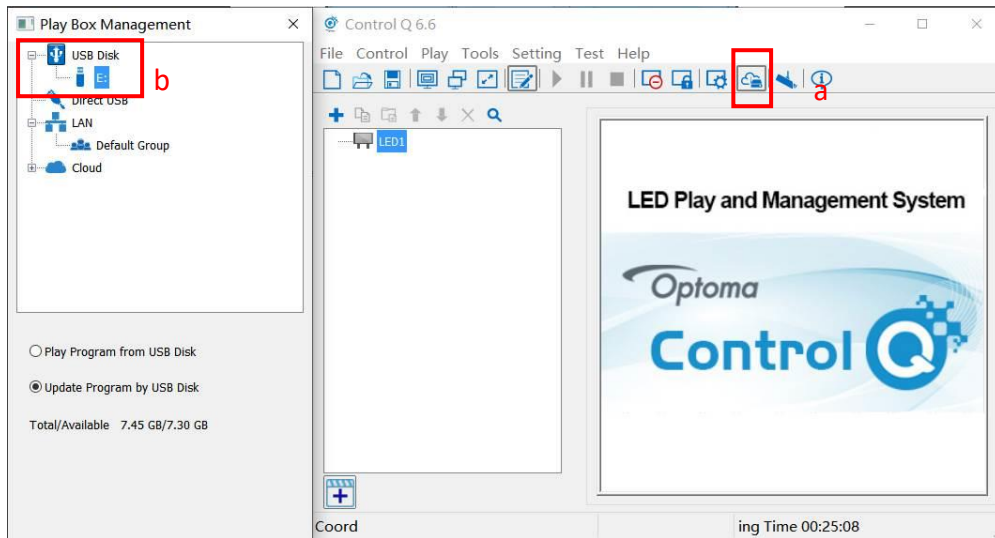

Figure 16

Step 4. In Program Editing Area, Click

c : Press “+”

d : Normal page

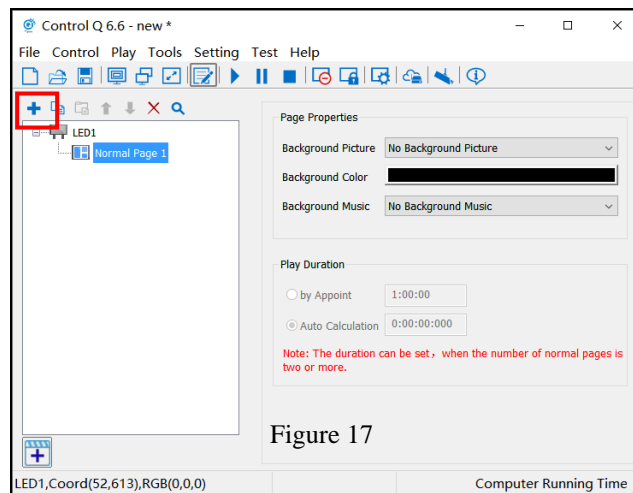

Figure 17

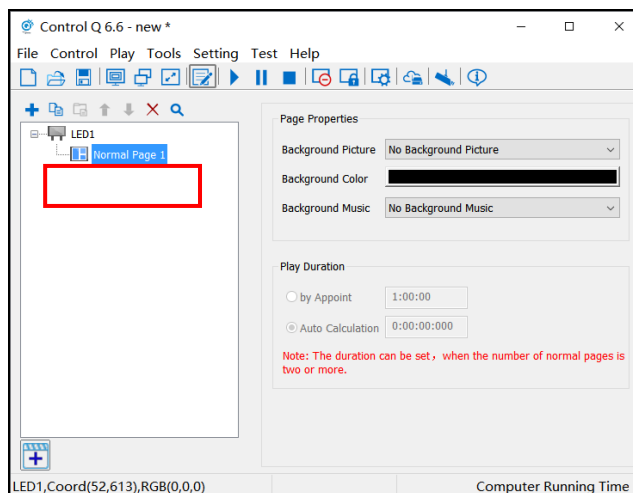

Figure 18

Step 5. Click
 e : Press “+”
 f : File Window

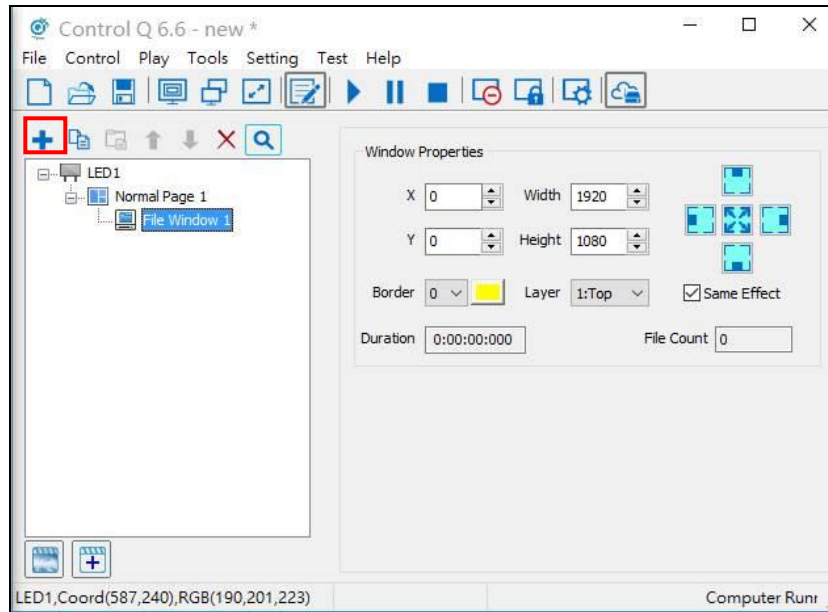

Figure 19

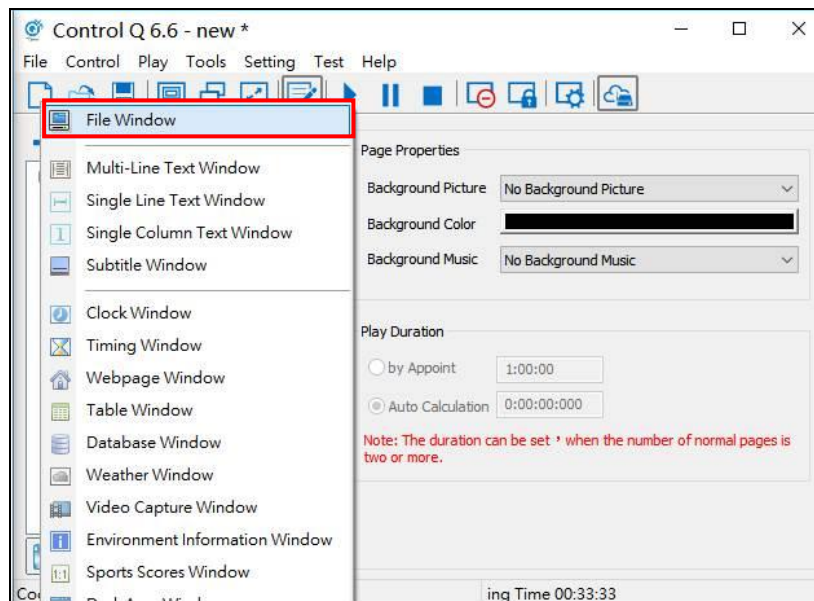

Figure 20

Step 6. Click

g : Press “+”

h : then Add the file type what you want to play

Note : In order to make the video to fit the screen, the Video resolution must be 1920x1080.

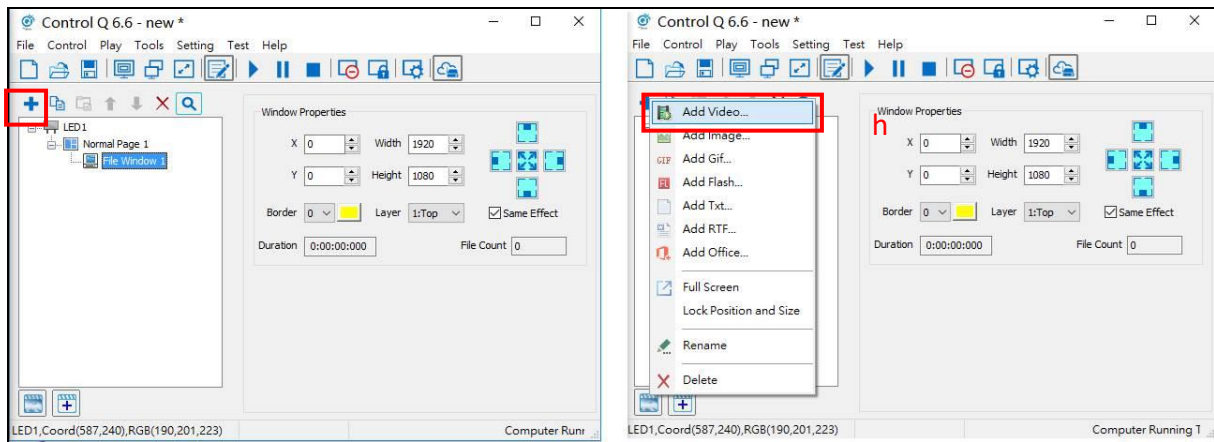

Figure 21

Step 7. Then we can see the content window for editing. If you want to add more content, repeat Step3~6.

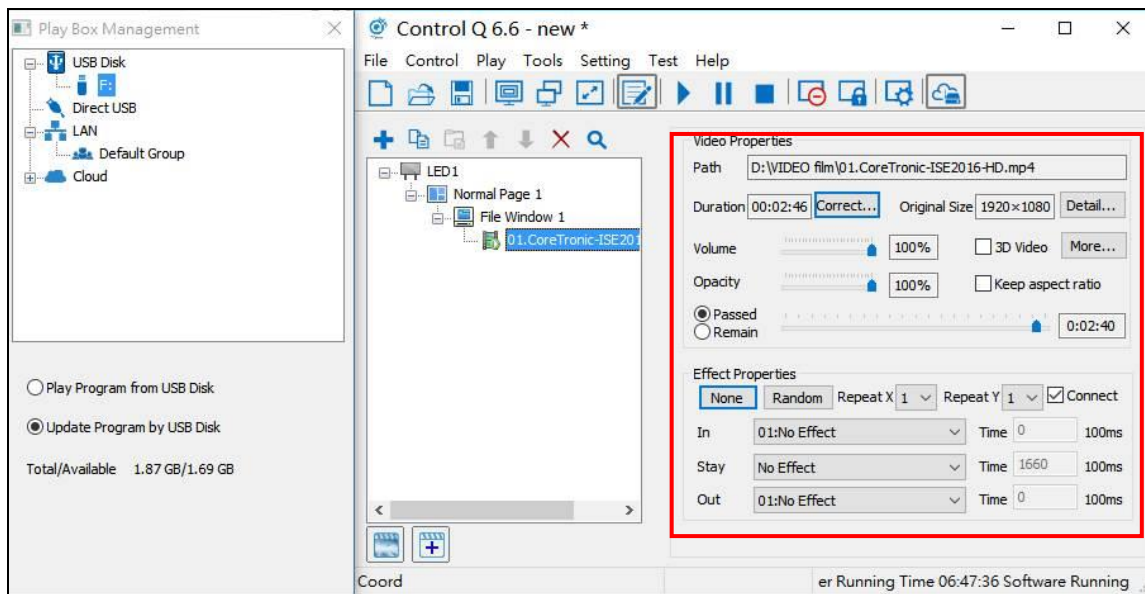

Figure 22

Step 8. Choose USB Disk Mode:

Play the program from the USB disk (automatically play the USB disk content after inserting it into the System Control Board ; the content won't be stored on the System Control Board)

Update the program from the USB disk (automatically play the USB disk content after inserting it into the System Control Board; the content will be stored on the System Control Board)

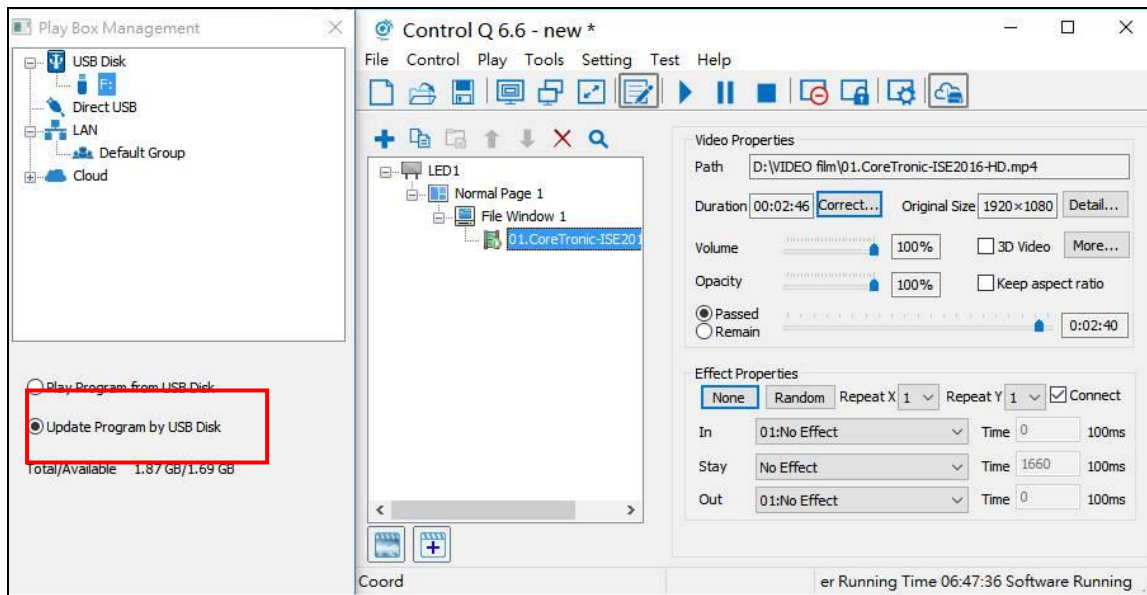

Figure 23

Step 9. Click Mouse right button / Publish program to the selected USB disk, key in Publishing Name / OK

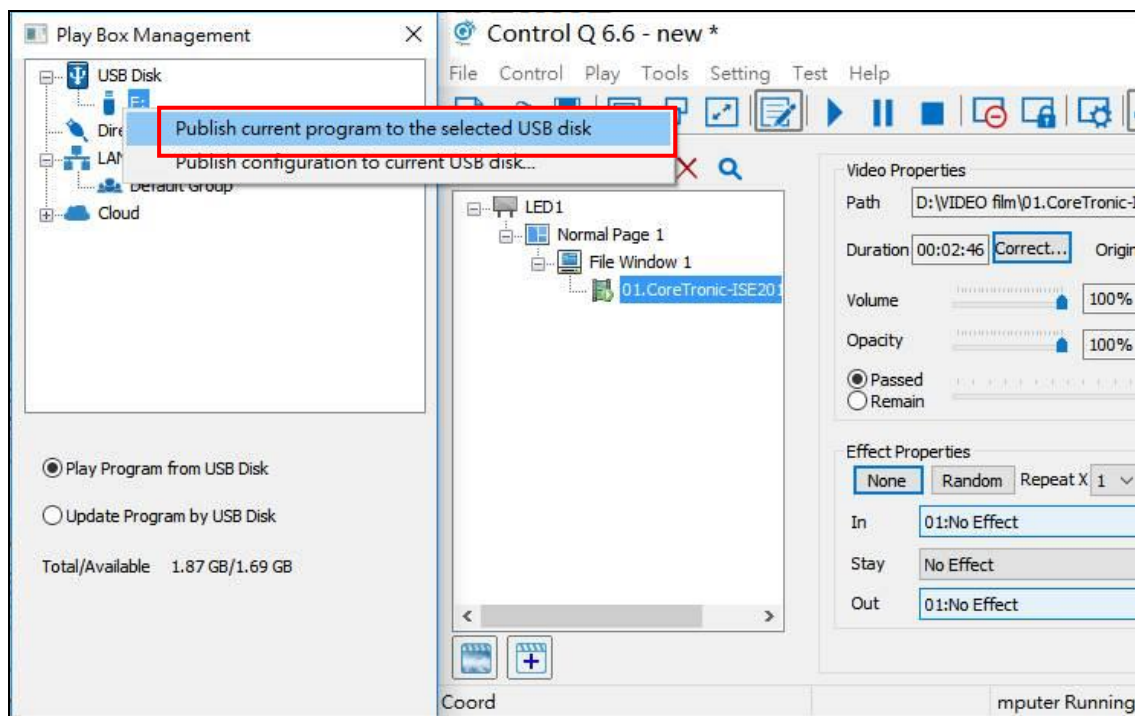

Figure 24

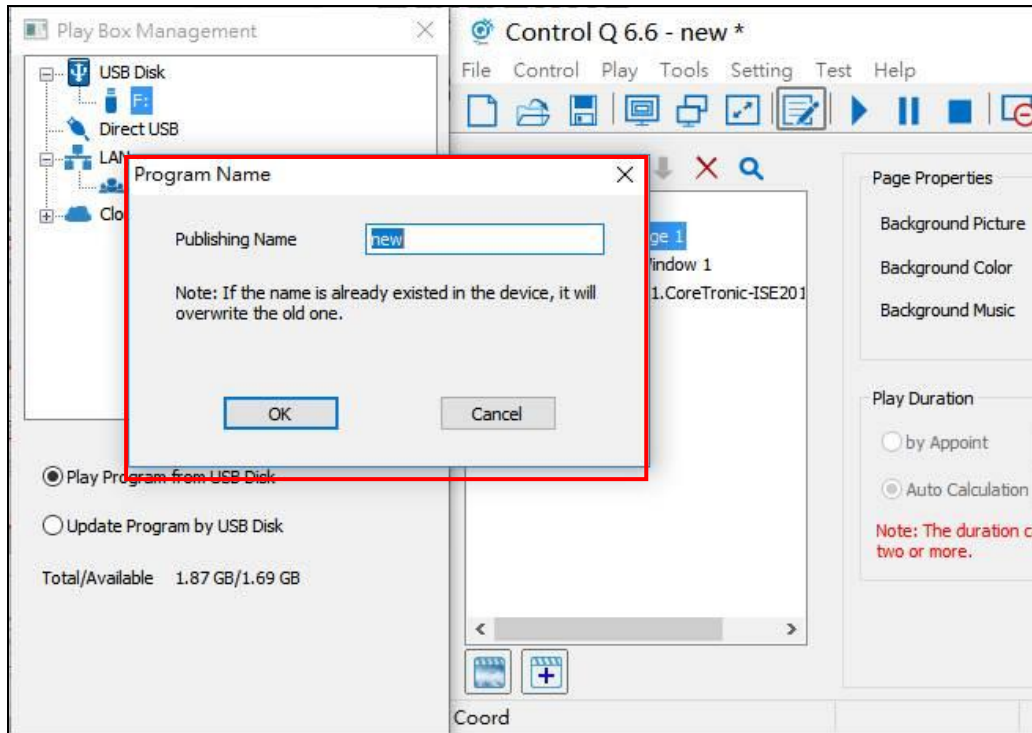

Figure 25

Step 10. After publishing program successfully

Insert USB disk into System Control Board USB port

Switch the signal source to the internal Media player(System Control Board)

Wait a moment, the content will paly.

Note: A rotating circle on the LED's upper left corner will appear during the updating procedure. You may unplug the USB drive after the circle disappears.

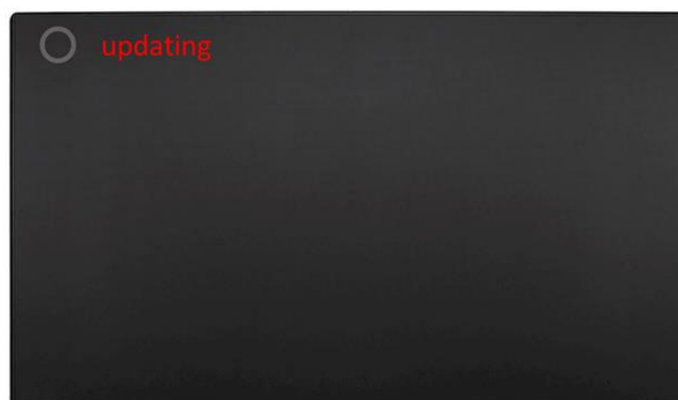

Figure 26

3. WIFI

Before using WiFi please connect USB dongle (provided) to the USB 2.0 port of the AIO QUAD and power on.

(1) Click LED display after connecting successfully, then click [More] and input password 'optoma' in the pop-up window, you will see the interface showed below. Check [WIFI] in network tab, and input your WIFI login information for [SSID] and [Password], then click [Apply] and [Refresh] to complete setting, click [Detail...] to check connection status.

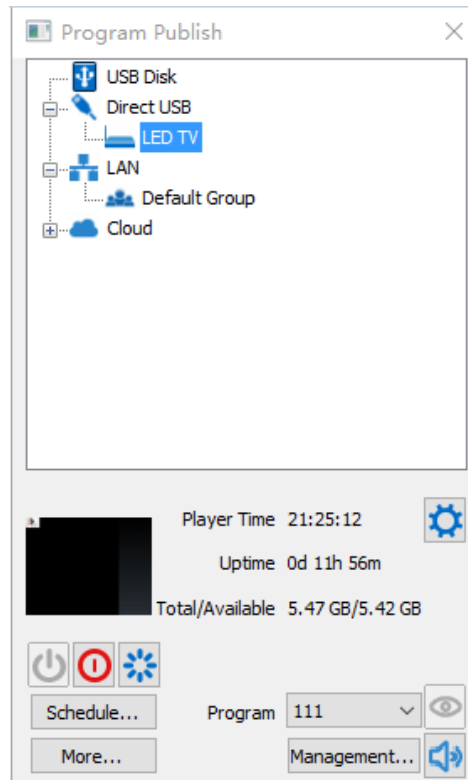

Figure 27

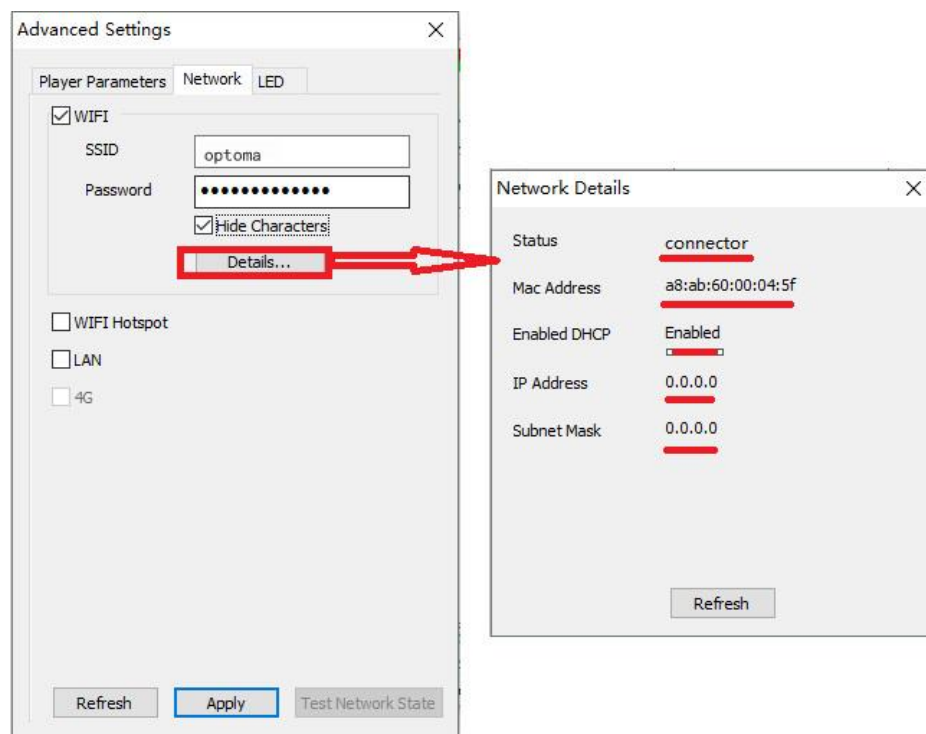

Figure 28

4. WIFI Hotspot

Input [SSID] and [Password] to use a WIFI Hotspot.

[Band]: 2.4GHz or 5GHz, 5GHz is available if your smartphone or PC can support 5GHz WIFI.

[Channel]: There are 1-14 optional channels to avoid network jam.

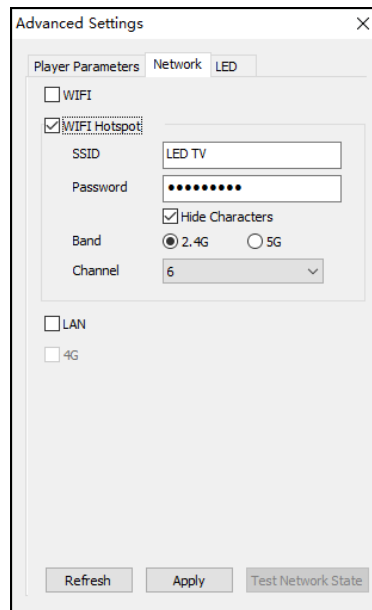

Figure 29

5. LAN

(1) Automatically Obtain IP Address (Default)

When you connect your LED display LAN port to a router, LED display will automatically obtain an IP address to access LAN.

(2) Use Following IP Address

Enter information for [IP], [Subnet Mask] and [Gateway] manual setup, then connect LED display LAN port to the router to access LAN.

(3) Details

Check network connection information like connection status, Mac Address, Enabled DHCP, IP Address and Subnet Mask .

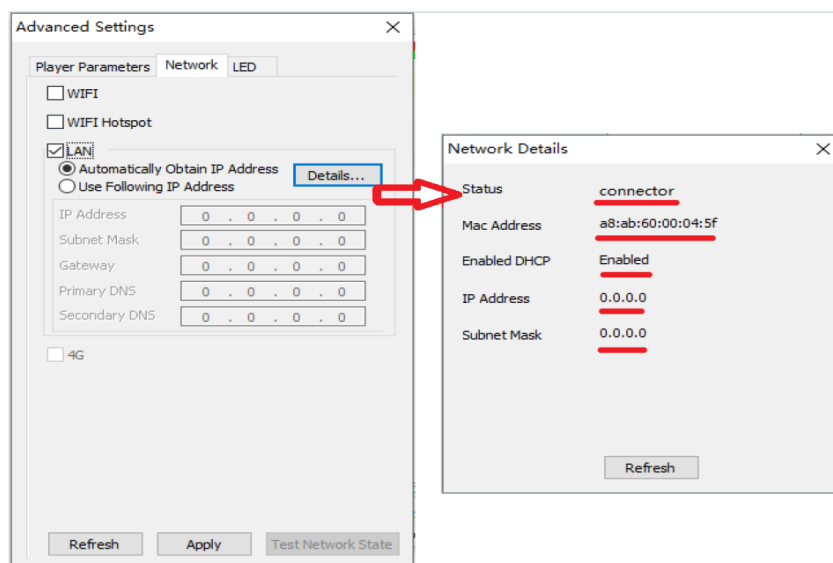

Figure 30

◆ Basic Settings

- Ensure LED display is functioning normally before setting LED display parameters.
- Connect LED display to PC with a standard USB-A Male to USB-B Male cable to set LED display parameters.

1. Play Box Date and Time: Click [Modify] to set up date and time, or time zone as well.

2. Timing Settings: Set wake-up and sleeping time, which works once is checked.

3. Play box Time: Display the setting time.

Running Time: Calculate the running time once LED display is powered on.

Capacity/Remain: View memory utilization.

4. Power on/Sleep/Restart: click shortcut to perform LED display operation like power on, sleep and restart.

5. Playing: Use the drop-down menu to choose programs to display quickly.

Program Management: Check, delete and choose program, and much more.

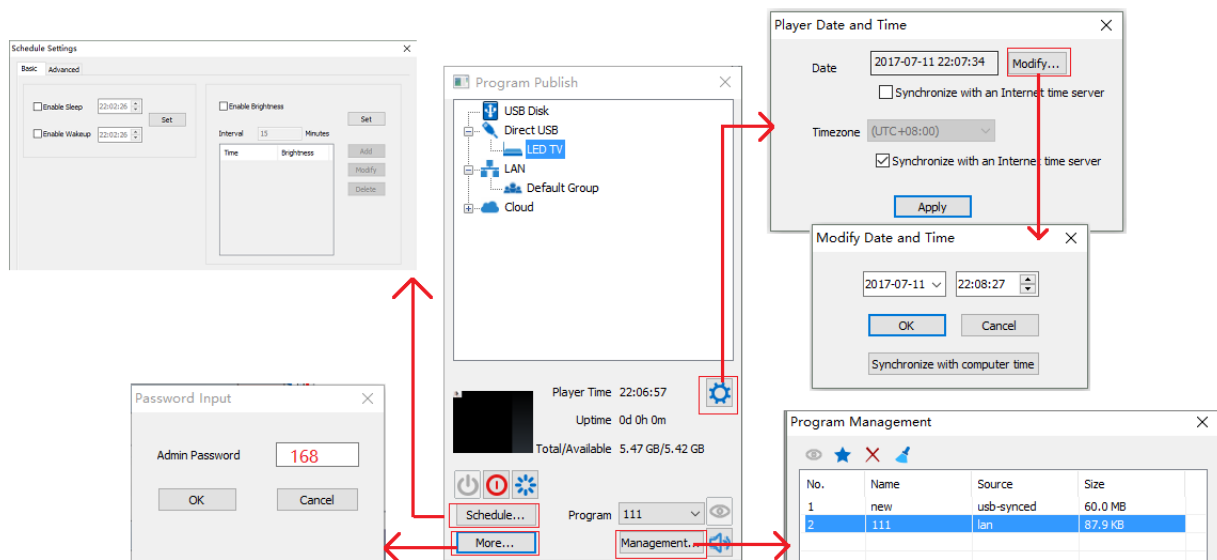

Figure 31

6. Playing Parameters

(1)Screen Resolution

The [Width] / [Height] has to be equal to or slightly larger than the actual screen resolution.

(2)Output

Every Frame (Default)

Every Other Frame (Choosing [every other frame] can help avoid lag when image loading area is too large).

(3)Control Area

Suggest to select [Custom] in control area, and modify the values according to your network interface control area, click [Apply] to complete setting.

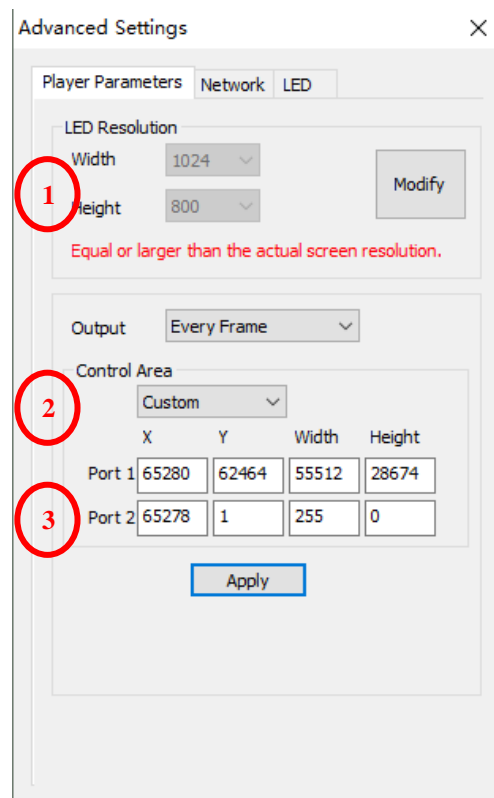

Figure 32

Program Editing

◆ Main Toolbar

The main toolbar provides the most commonly used tool shortcut icons, including program file operation, display / hide of the play window, switch between dual monitor, editing / stowage of the software main interface, program playback, sending program to dual mode card , close / display large screen, cloud release, view help and other functions.



◆ Right-Click Menu of the Play Page

Right-click in the play window, pop-up menu as below, the menu supports a variety of operations on the program file , support the program playback page switching and related operations for the window.

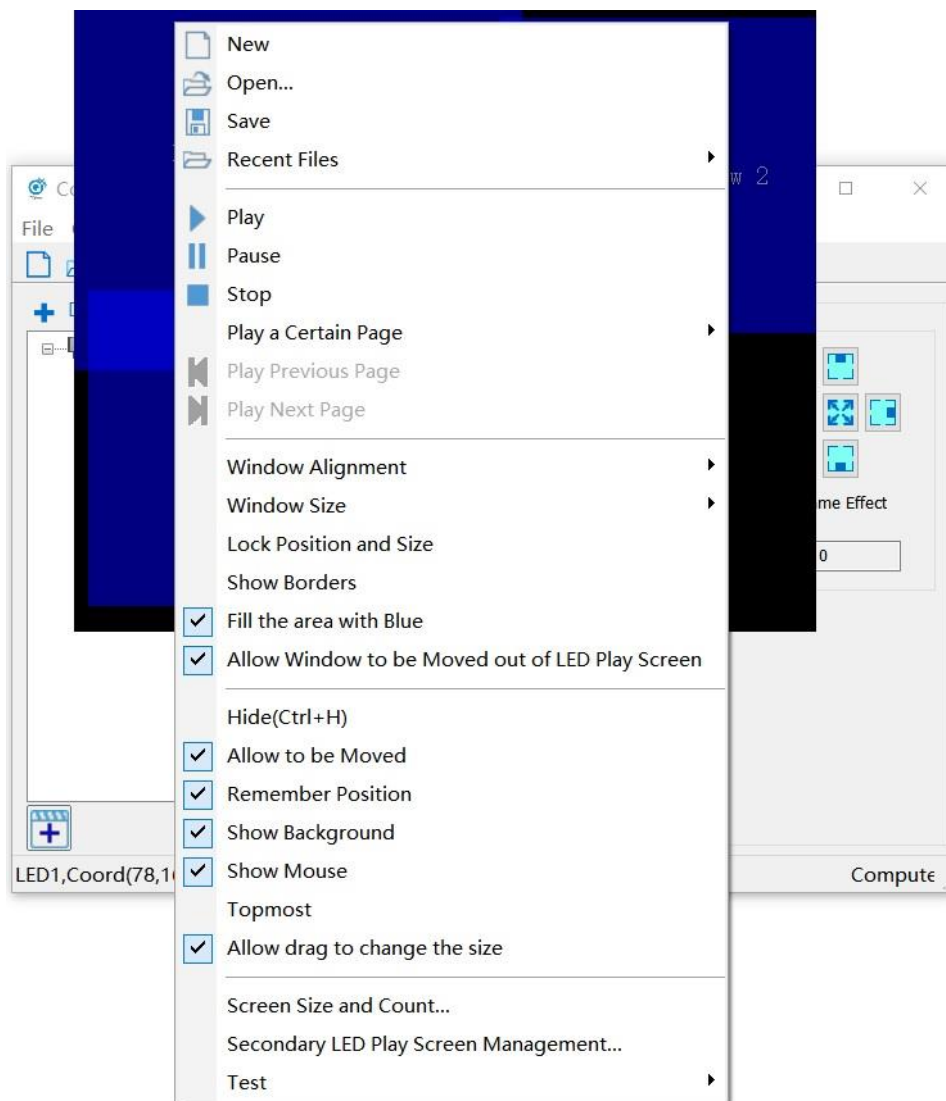

Figure 1

◆ **Program Edit Toolbar**



From left to right

1. Add program windows or play content bars: Add program windows or play content bars in the corresponding position.
2. Copy: Copy the selected items and everything below.
3. Paste: Paste the copied contents
4. Move up: Move the selected content to the front.
5. Move down: Move the selected content to the back.
6. Delete: Remove the selected items and everything below.
7. Close /expand :Close /expand all the content under the selected item.
8. Search: enter keywords to find the required content to do the relevant operation

◆ **Play File of Program**

The play file of this software corresponds to a file saved as *.vsn, consisting of one or more program pages. There are two types of program pages: normal page and global page. The normal program page is the main component of the program, which can be played in sequence. There is only one global program page, which is played throughout the whole program, mainly used for fixed content such as clock, company logo, etc. The program page consists of one or more program Windows. The program window is used to display what the user wants to play.

◆ **Program Structure**

The Control Q program tree area consists of four levels , they are the LED display, program page, program window, and play content.

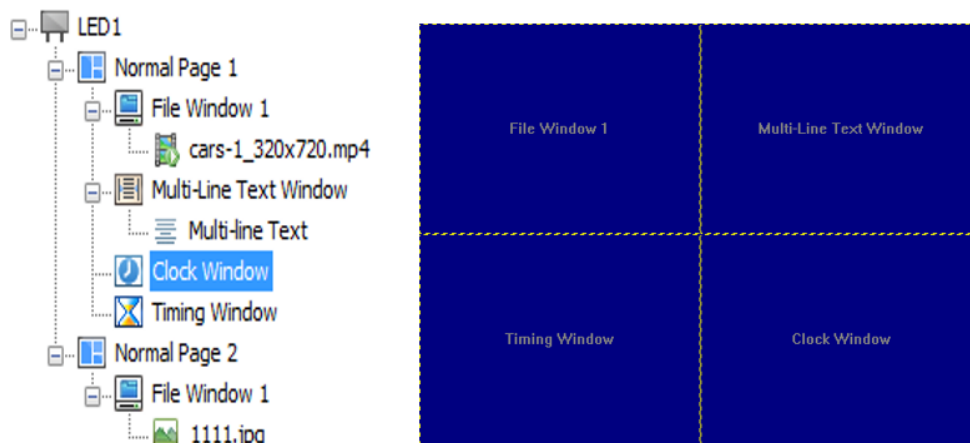

Figure 2

LED display: It decided what to display to the LED large screen. Each "LED display" is a parallel relationship and can add multiple program pages.

Program page: normal page and global page.

Play content: The specific content displayed on the LED screen. Including video, picture, GIF, FLASH, text files, Office files, Excel worksheet, clock, timing, web page, database, weather forecast, external video, environmental information, sports score, desktop copies. Depending on the content, there are different attribute settings.

◆ **Program Page**

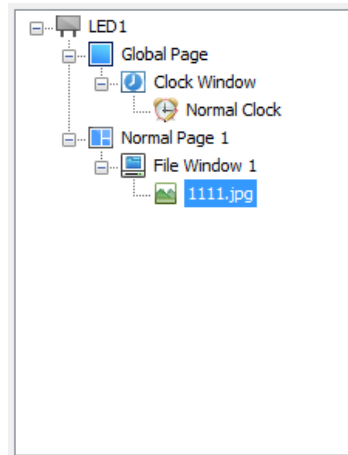

Figure 3

Depending on the nature, the program page is divided into global page and normal page.

Normal page: Normal page can contain multiple Windows, each of which has a different window layout. The same playtime can contain more than one normal page. Multiple normal pages loop through the top to bottom. In most cases, a playtime only requires a normal page.

Figure 4

Global Page: A program page that has been played during playback and can contain multiple windows

Global page and normal page are synchronized, and the global page is always located at the top of the normal page. If you want to display content such as clock, weather forecast, corporate logo, etc. in a fixed location, you can edit the media to the global page. Each program can only be set to a global page.

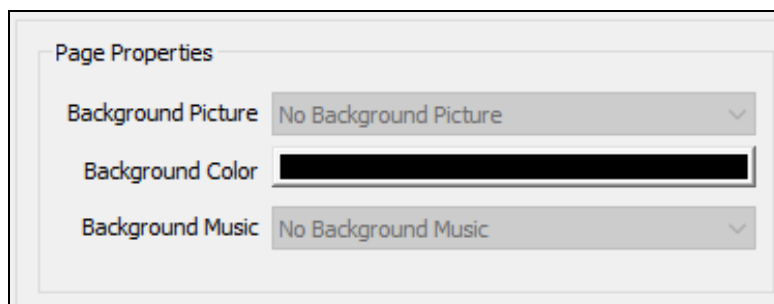

Figure 5

◆ **Program Window**

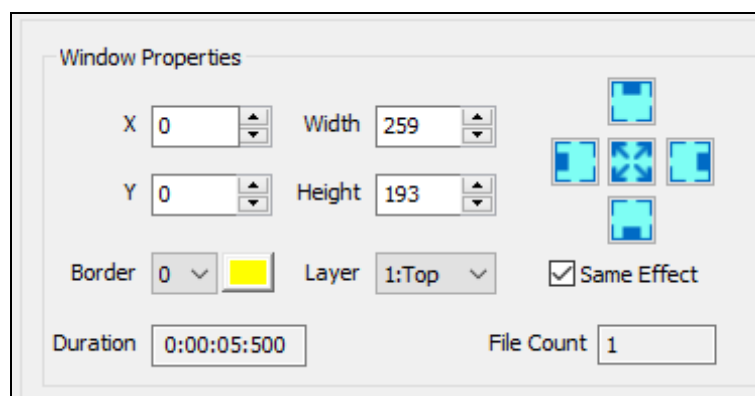

Figure 6

The program window is the playback partition window of the program, which determines the layout and stacking level of the program in the program page. The window must belong to the program page and can't exist alone. Including file window, multi-line text window, single-line text window, clock window, timing window, web page window, table window, database window, weather forecast window, external video window, environmental information window, sports score window, desktop copy window.

File window: the most important window, you can play video, pictures, animation, text, Office and other commonly used files.

Multi-line text window: used to play multiple lines of text, such as RTF \ TXT.

Single-line text window: used to play a single line of text, such as notification, advertising and other text.

Clock window: used to edit the clock, including analog clock, digital clock and exquisite clock.

Timing window: used for timing, support positive timing and countdown.

Web Page window: used to display the contents of the specified web page.

Table window: used to edit, play tabular data.

Database window: used to play ACCESS database, ODBC database and SQL Server database.

Weather forecast window: Used to display regional weather forecasts.

External video window: used to add external video to the play window, mainly for the acquisition card.

Environmental information window: used to display the temperature, humidity, smoke, noise and other information that multi-function card collected back.

Sports score window: for sports score editing and display.

Desktop copy window: used to copy the desktop display area.

◆ Program Edit Process

1. Set the screen size

It is very important to set the screen size correctly , Otherwise, the program may display incomplete or abnormal display .

2. How to set the screen size

Click the main menu [Control Screen] → [Screen Management], pop-up screen management window, set the number of LED screen, the starting position, size, etc.. Note: The size of the LED screen corresponds to the actual size of the LED display, the unit is the pixel.

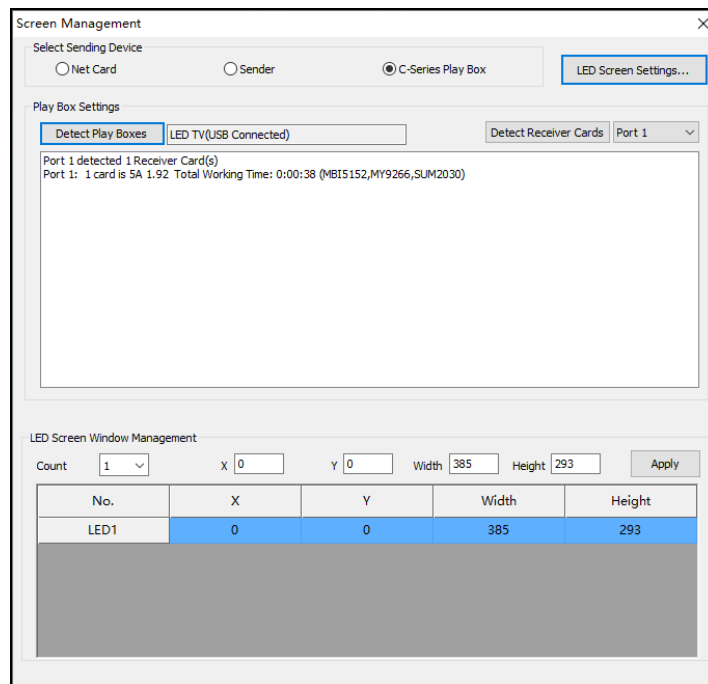

Figure 7

◆ Async Content Editing

When you open the software, you will see [LED1] in program editing area. Left-click to choose [LED1]then right-click to add [Normal Page], you can add [File Window] in [Normal Page], then [Add Image] and [Add Video] under the [File Window] to add media for asynchronous play.

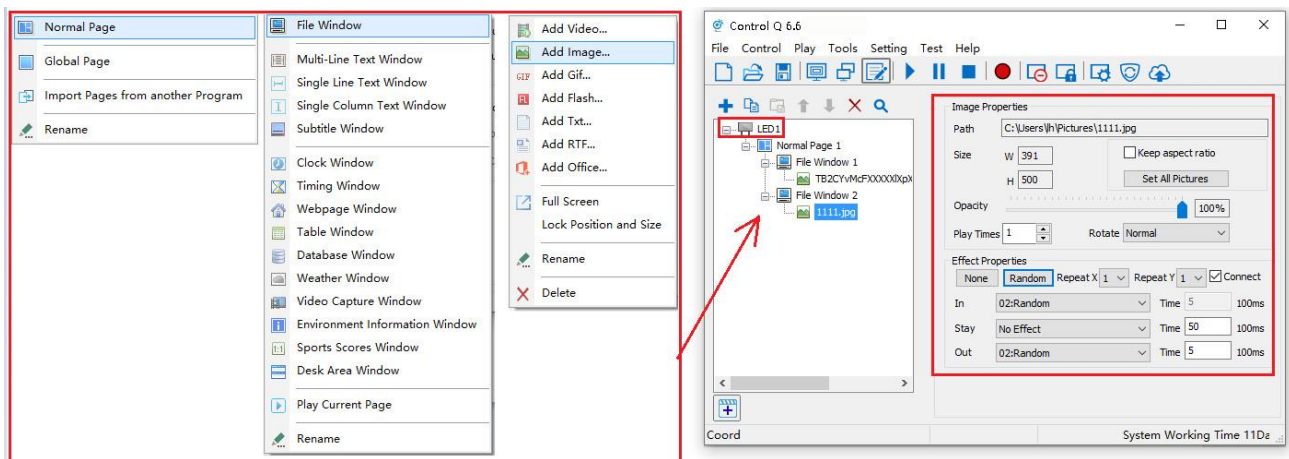

Figure 8

◆ **Publish Programs through USB/WIFI/LAN**

The same method can be used in USB/WIFI/LAN connections.

- (1) In program editing area, after finishing program editing, select the program page that you are going to publish;
- (2) In [Program Publish], click [Normal Page 1] and then right-click LED display to choose [Publish current program to the selected player], rename and upload the program to publish.

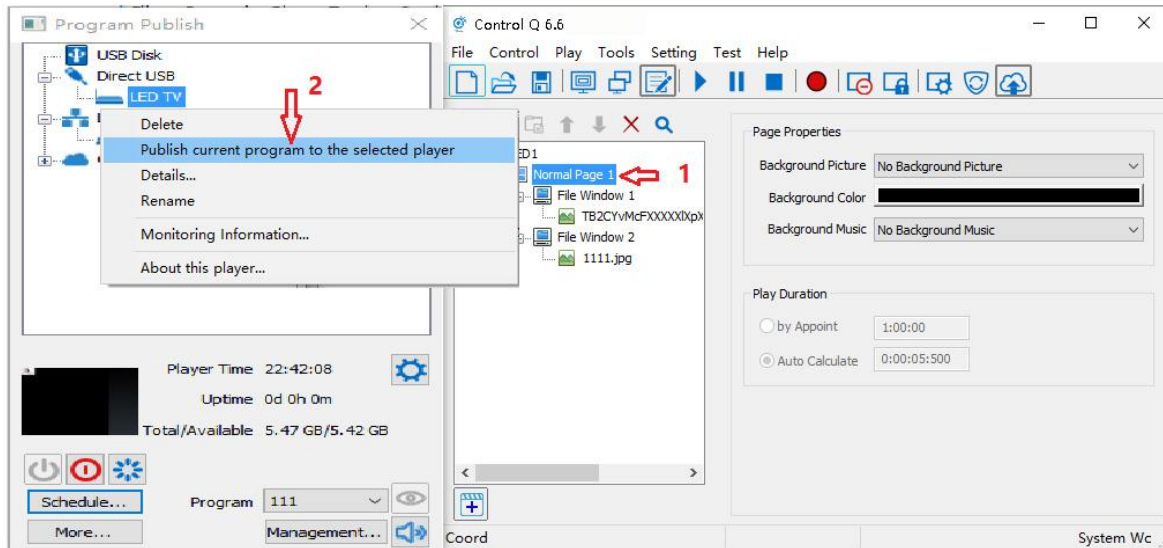

Figure 9

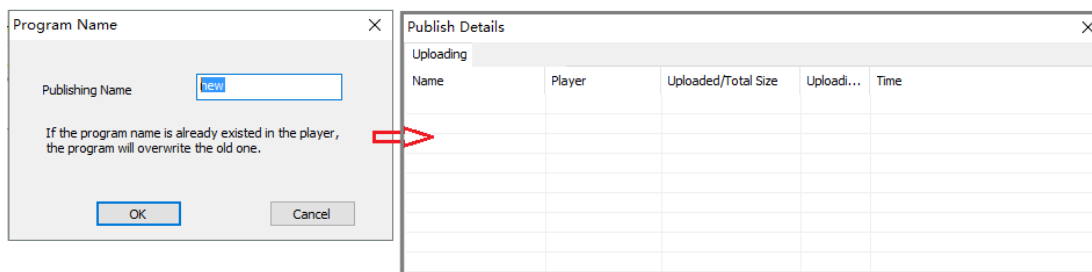



Figure 10

◆ **Publish Programs through USB disk**

- (1) Connect USB disk to PC USB port.
- (2) Click icon  to extend program publish window.

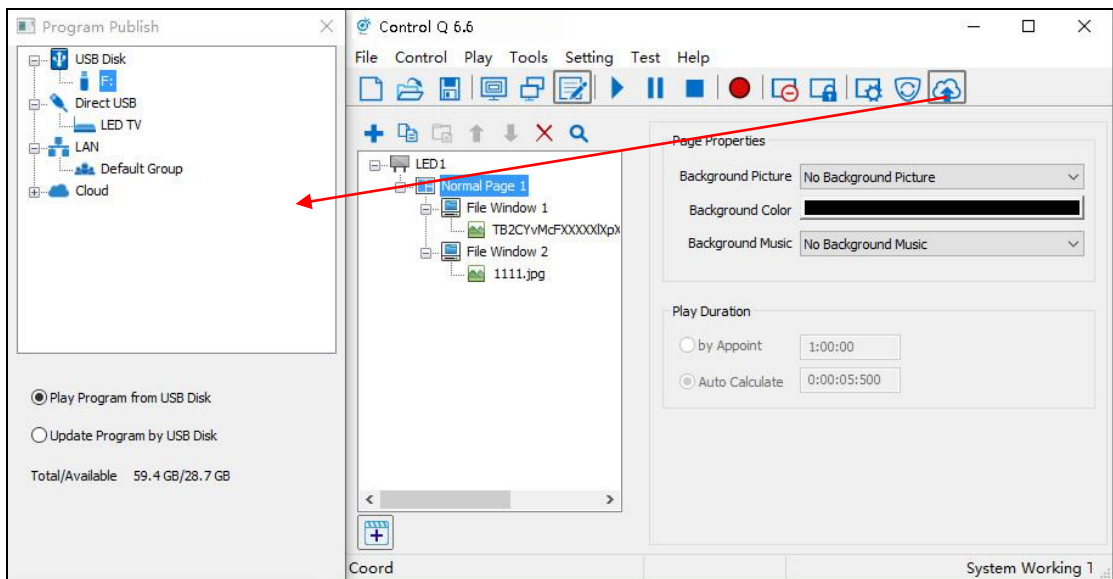

Figure 11

Note: Recommend to remove previous contents of the USB disk before using it to update or play new contents, so as to avoid any problems.

(3) Auto identify the inserted USB disk click [USB Disk] to choose [F].

1. Select [Normal Page 1] in program editing area.

2. Choose[Update Program by USB Disk]

- Play Program from USB Disk (Autoplay USB disk contents after inserting to LED display and the content won't be stored in LED display).
- Update Program by USB Disk (Autoplay USB disk content after inserting to LED display, the content will be stored in LED display).

3. Click[F]under [USB Disk], and then right-click to choose [Publish current program to the selected USB disk], after publishing program successfully, connect USB disk to LED display USB port and you can update programs.

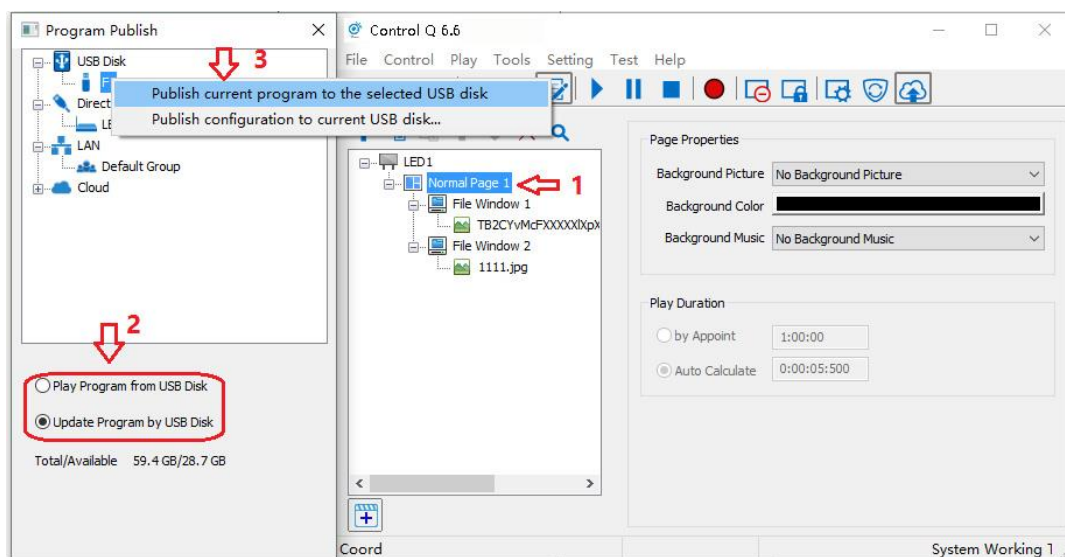

Figure 12

Note: A rotating circle in LED upper left corner will appear during the update procedure. You may unplug the USB disk after the circle disappears.

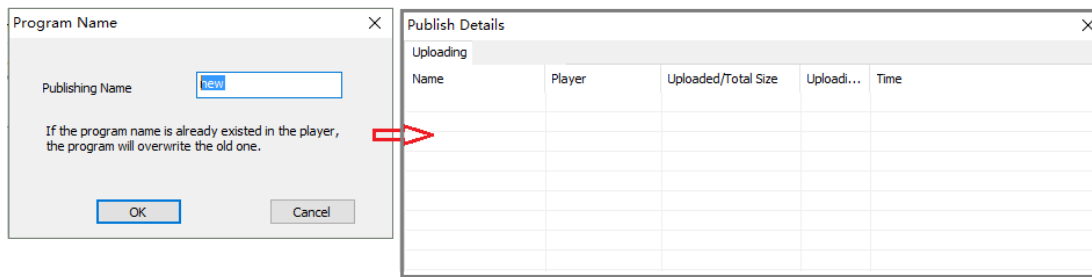

Figure 13

◆ **Sync Playing**

In sync play, your LED display plays contents sent to its HDMI port by an external source like your PC.

Note: LED display will automatically switch to play sync signal content when an external HDMI signal input is detected. You can press [INPUT SWITCH] button to return async signal content playing.

Network and Management

◆ Connection and Management

(1) LAN connection: Connect LED display to LAN through WIFI or LAN port.

(2) Network management: After the controlled terminal (PC, Mobile devices, etc) and LED display are connected into the same LAN, unplug the USB cable, select [LAN], right-click and choose [Refresh], FHDQ130 processor will auto identify LED display and place it into Default Group. You can manage your LED display under Default Group.

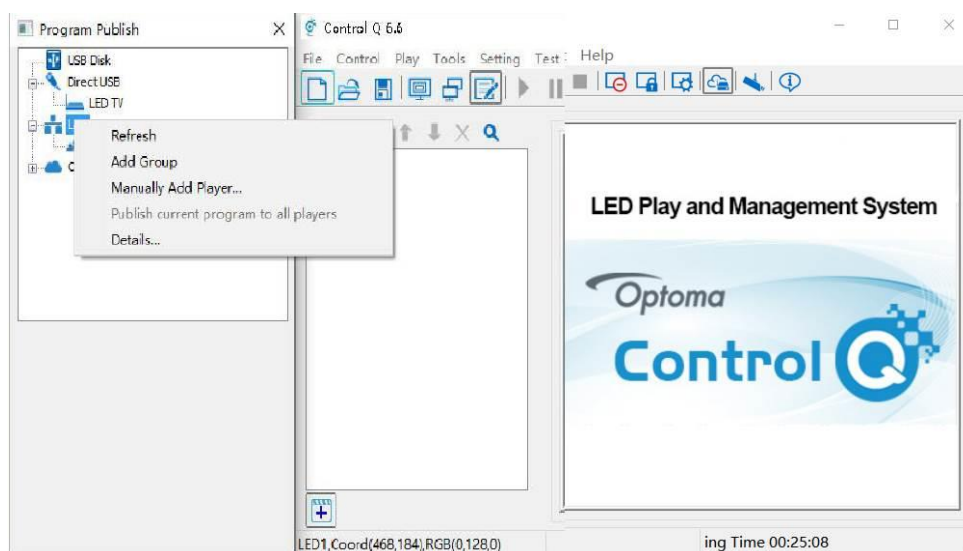

Figure 1

◆ Add Group and Device

(1) Add Group: select [LAN], right-click to choose [Add Group].

(2) Add Device: Select any player group you need, and right-click to choose [Manually Add Player], then input LED display's corresponding IP (Even if your device did not connect to network).

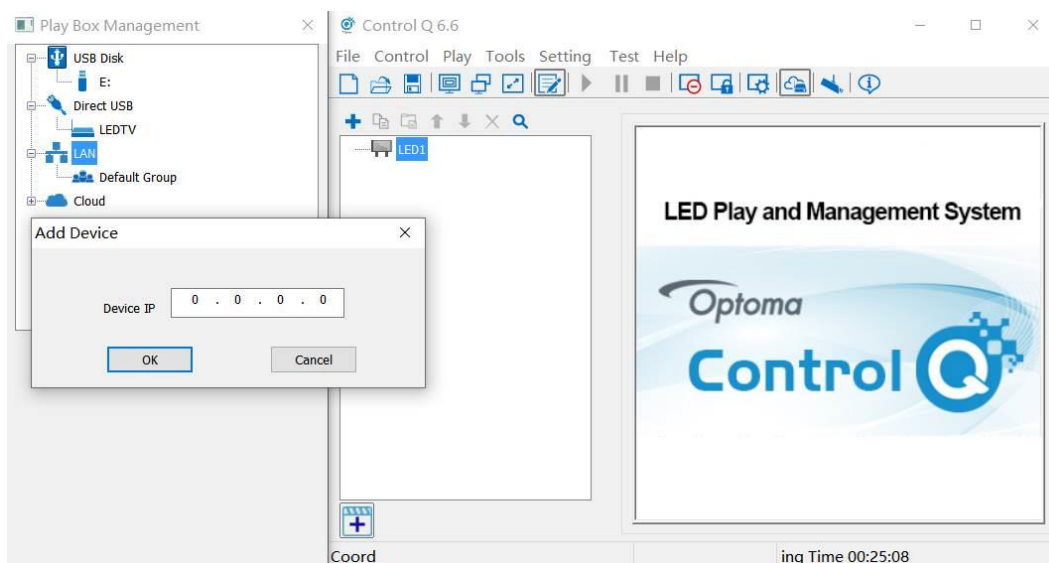

Figure 2

APP Operation Instructions

◆ System Overview

- 1) Optoma Control Q supports system which is higher than Android 5.0.
- 2) Optoma Control Q supports all the C series products.

◆ APP Installation Instructions

Log in Google Play and search LH display , download and install the App.



◆ APP Operating Instructions

1) Network Connections

The client phone needs to be controlled within the same LAN as the C series play box. There are two ways, one is to connect the hot spot of the C series with the mobile phone, and the other is to connect the C series play box and mobile phone to the same network.

2) USB/WIFI/LAN/ Connection Section

Screen connection via PC USB.You can set up the display screen, program content management.

WIFI/LAN connects to screen. You can set up the display screen, program content management.(You need to use a USB connected to PC to set screen parameters, this function can be achieved.)

3) Language Switching

The downloaded APP will automatically adapt the language of the mobile phone system.

◆ Search Terminals

Click the icon at the top left corner and select the terminal list. The terminal list will display all the devices in the current LAN, as shown below.

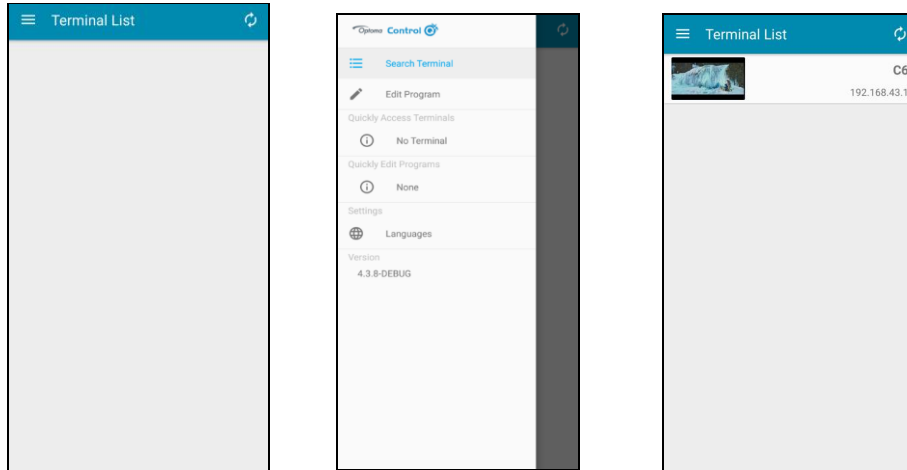

If the list doesn't display any device, you can pull down or hit the  to refresh list. If this doesn't work, please check the network connection of the mobile phone.

◆ Terminal Control

Select the terminal to be controlled in the terminal list, and click to enter the control interface.

A. Control

Select the required functions to control directly.

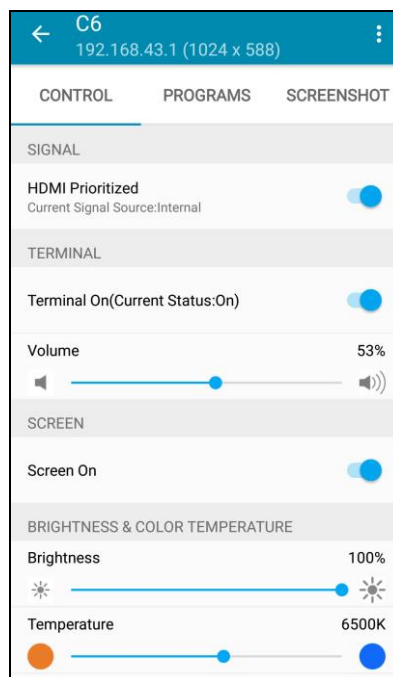

Signal : Asynchronous and synchronous HDMI switching

Terminal : on/off switch › volume adjustment

Screen : on/off switch

Brightness and color temperature : Brightness/color temperature adjustment

B. Programs

Click [PROGRAMS] and select the program to complete the program switch. Long press the program 2 seconds to enter the delete selection, you can choose to delete the program you want to delete.

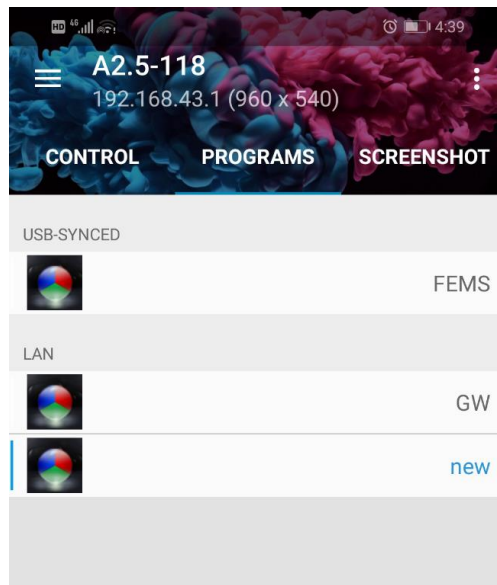

C. Screenshot

Screenshot functionality allows the user to see real time content from the Quad on your device. Click the refresh button in the upper right corner to refresh the image.

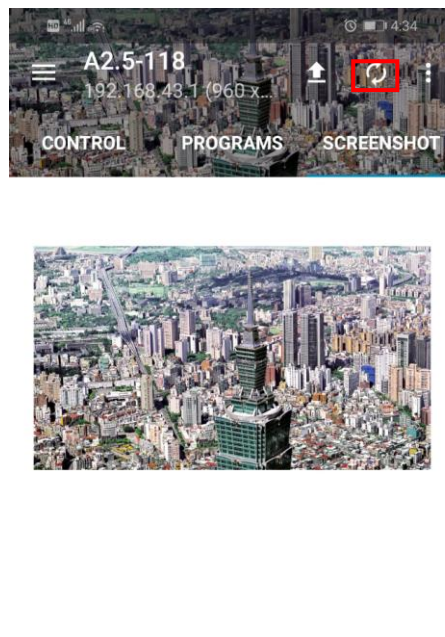

◆ Edit Program

Open the APP, click the top right button to select [Edit Program], and enter the editing interface. Please refer to below screenshots for details.

A. Set the screen size

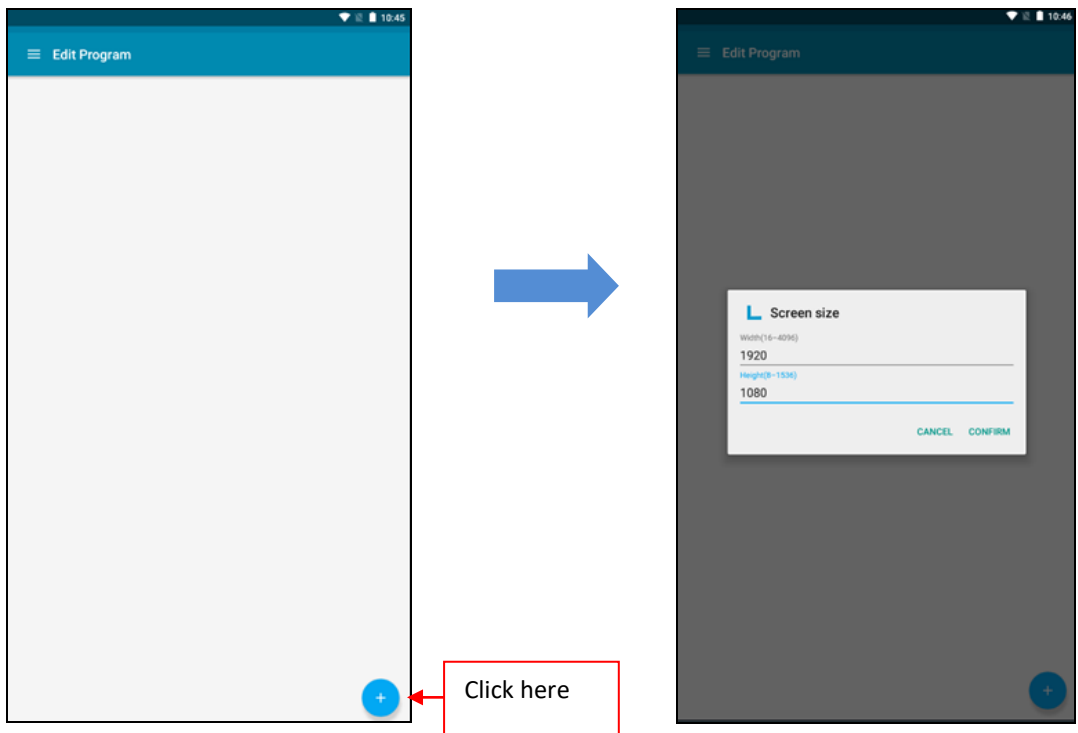
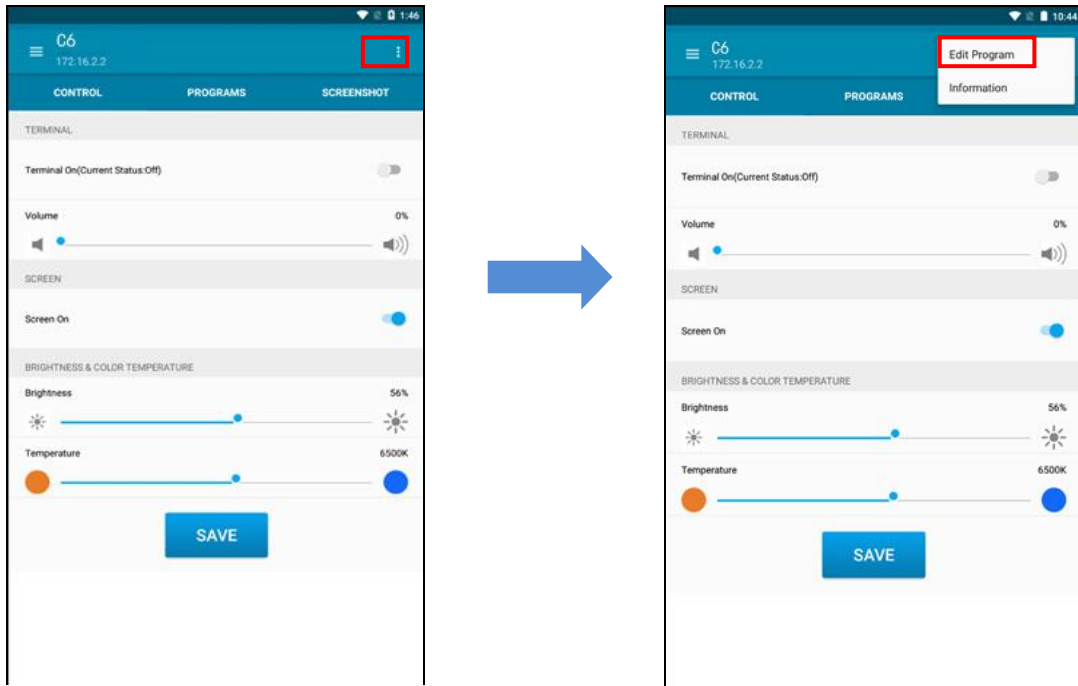

B. Set the window size and add content

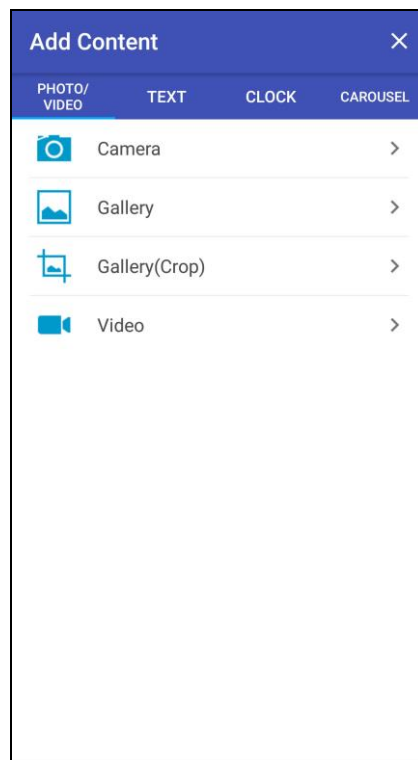
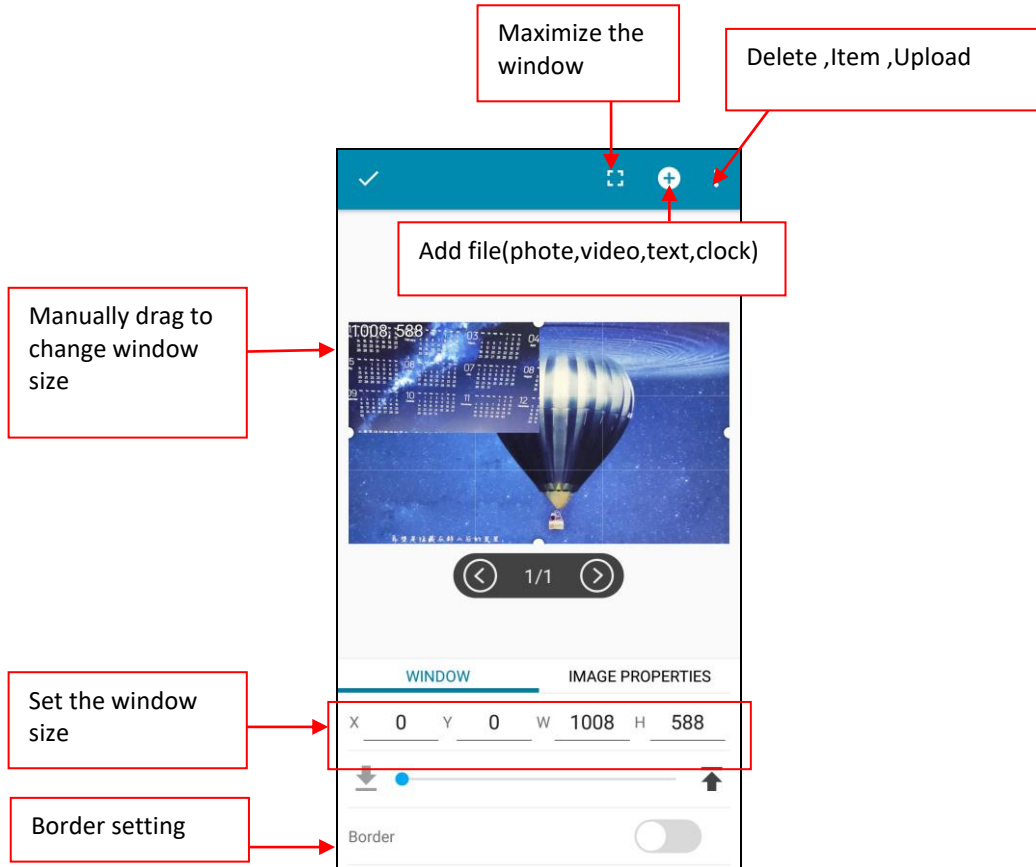

C. Upload program

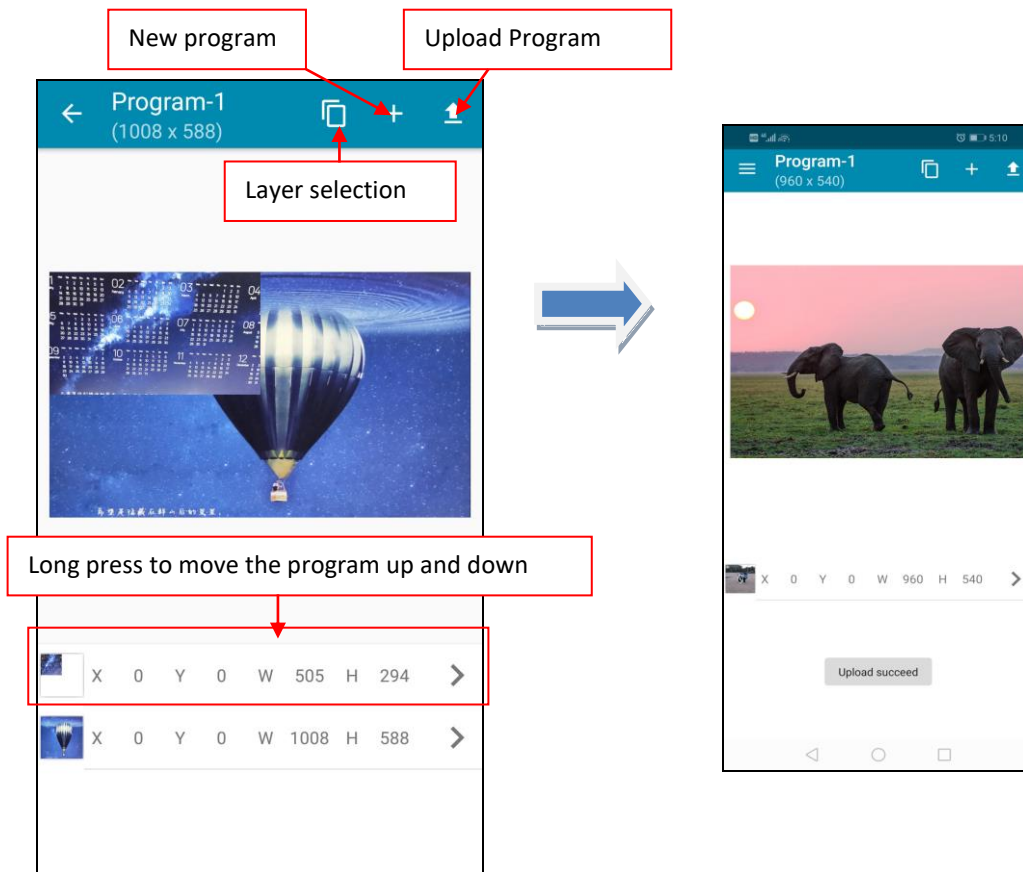

◆ Version Information

Select the terminal in the terminal list, and then click the upper right button to view it, as shown below.

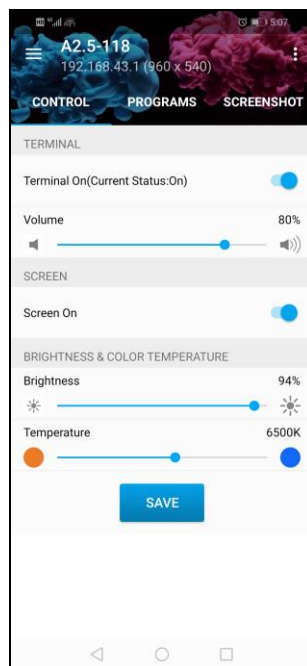
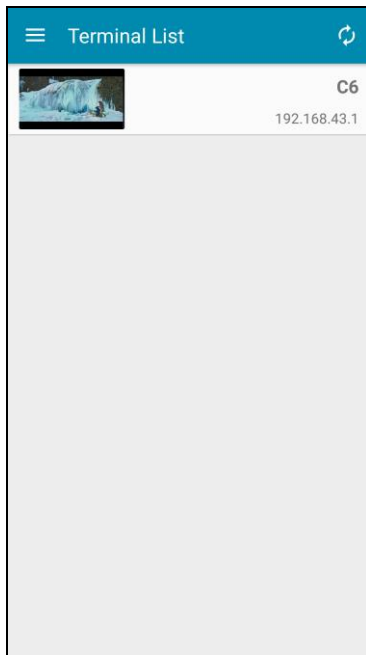

Appendix A SPECIFICATIONS

Parameter	Unit	Value	
Brightness	Nits	600(Max)	
Color temperature	deg. K	6,500	
Viewing angle - Horizontal (50% brightness)	deg.	160(+80/-80)	
Viewing angle - Vertical (50% brightness)	deg.	160(+80/-80)	
Panel weight(max)	kg / lb	125/275.5	
weight(max)(sq.m)	kg / lb	26/57	
Panel diagonal/ Display diagonal	mm / ft	3357.5/11.02	3304.4/10.84
Panel width / Display width	mm / ft	2919/9.58	2880/9.45
Panel height / Display height	mm / ft	1659/5.44	1620/5.31
Panel depth(min)	mm / ft	38/0.125	
Panel area / Display area	sq.m / sq.ft	4.84/52	4.67/50
Panel material		Aluminum	
Panel Color	/	Pantone Matte Black	
Aspect ratio		16:9	
Ingress protection(Front/rear)	IP	IP40/IP20	
Operating / storage temperature	deg. C	0 to +40 / -10 to 60	
Operating / storage humidity	%	< 90 (Without condensation)	
Pixel type and configuration	R/G/B	SMD 4 in 1	
Pixel pitch	mm	1.5	
Pixel matrix per Panel		1,920x1,080	
Pixel per Panel		2,073,600	
Pixel Lines per meter		666	
Pixel per sq. meter		444,444	
Recommended minimum viewing distance	m	1.5	
Colors		281 Trillion	
Grey scale (linear)	Levels	65,536 levels per color	
Brightness control	Levels	100	
Contrast ratio		5,000:1	
Processing depth	bit	16	
Video frame rate	Hertz	50/60	
Display refresh rate	Hertz	≥3,000	
Input voltage (nominal)	VAC	200 to 240	
Input power frequency	Hertz	50 to 60	
Input power (max)	VA	3,000	
Lifetime (50% brightness)	Hours	≥100,000	
Panel input format		USB/HDMI/LAN/VGA/3G-SDI/WIFI	
Data interconnection		HDMI/LAN/VGA/3G-SDI/WIFI	
Mounting system		Wall Mount, Hanging or Stand with support	
Panel Maintenance		Front Access	

(PA)

* Specification subjected to change without prior notice

PC Compatibility

Mode	Resolution	Refresh Rate (Hz)	SDI	HDMI 1	HDBT	HDMI 2	VGA	
SVGA	800 x 600	56	NO	YES	YES	YES	YES	
		60	NO	YES	YES	YES	YES	
XGA	1024 x 768	60	NO	YES	YES	YES	YES	
720p	1280 x 720	50	YES	YES	YES	YES	YES	
		60	YES	YES	YES	YES	YES	
WXGA	1280 x 800	60	NO	YES	YES	YES	YES	
SXGA	1280 x 1024	60	NO	YES	YES	YES	YES	
FWXGA	1366 x 768	60	NO	YES	YES	YES	YES	
SXGA+	1400 x 1050	60	NO	YES	YES	YES	YES	
WXGA+	1440 x 900	60	NO	YES	YES	YES	YES	
UXGA	1600 x 1200	60	NO	YES	YES	YES	YES	
1080i	1920 x 1080	50	YES	YES	YES	YES	YES	
		60	YES	YES	YES	YES	YES	
1080p		24	YES	YES	YES	YES	YES	YES
		30	YES	YES	YES	YES	YES	YES
		50	YES	YES	YES	YES	YES	YES
		60	YES	YES	YES	YES	YES	YES

Appendix B Procedure for Intelligent Module Replacement

When you find the intelligent module is malfunctioning, you can replace it with the following procedure:

1. Power off the LED display;
2. Locate the problem intelligent module;
3. Remove the intelligent module with the magnetic tool;
4. Mount a new intelligent module back to the same position as the problem one;
5. Make sure the intelligent module is firmly mounted;
6. Power on the LED display ;
7. Please check and make sure the replaced intelligent module is functioning well.

Appendix C Troubleshooting Guide

	Description	Inspection	Remove/replace
1	The screen is blurred.	Check if the source is correct. Whether the wire and connector are damaged.	Signal source, signal source connection
2	Picture discontinuity.	Check if the screen reference has been modified.	Recorrect screen parameters (reference manual or operated by a professional)
3	The picture is too dark.	Check if the source is correct. Whether the wire and connector are damaged. Use the remote control to adjust the brightness or use the on-screen buttons to adjust the brightness.	-
4	Unable to enter system.	Professional after-sales support required.	-
5	The green light keeps flashing after starting.	Professional after-sales support required.	-
6	The remote control is not working.	Check and replace with the same type of remote control battery, Whether the IR is aligned with the screen when using.	Replace with the same type of remote control battery.
7	The left and right of the screen are not horizontal.	Check if placement is horizontal. Whether the screen is installed correctly.	-
8	Audio no output.	Check and replace with the same type of remote control battery, Whether the IR is aligned with the screen when using. Whether the signal source has audio or not, the audio is not controlled by remote control when synchronizing signals.	-
9	Audio output volume is too low.	Whether the signal source has an audio source or not, the volume can't be controlled on the screen when synchronizing signals. Whether the IR is aligned with the screen when using. Check if the screen button function is normal.	-

Appendix D Mechanical Assembly

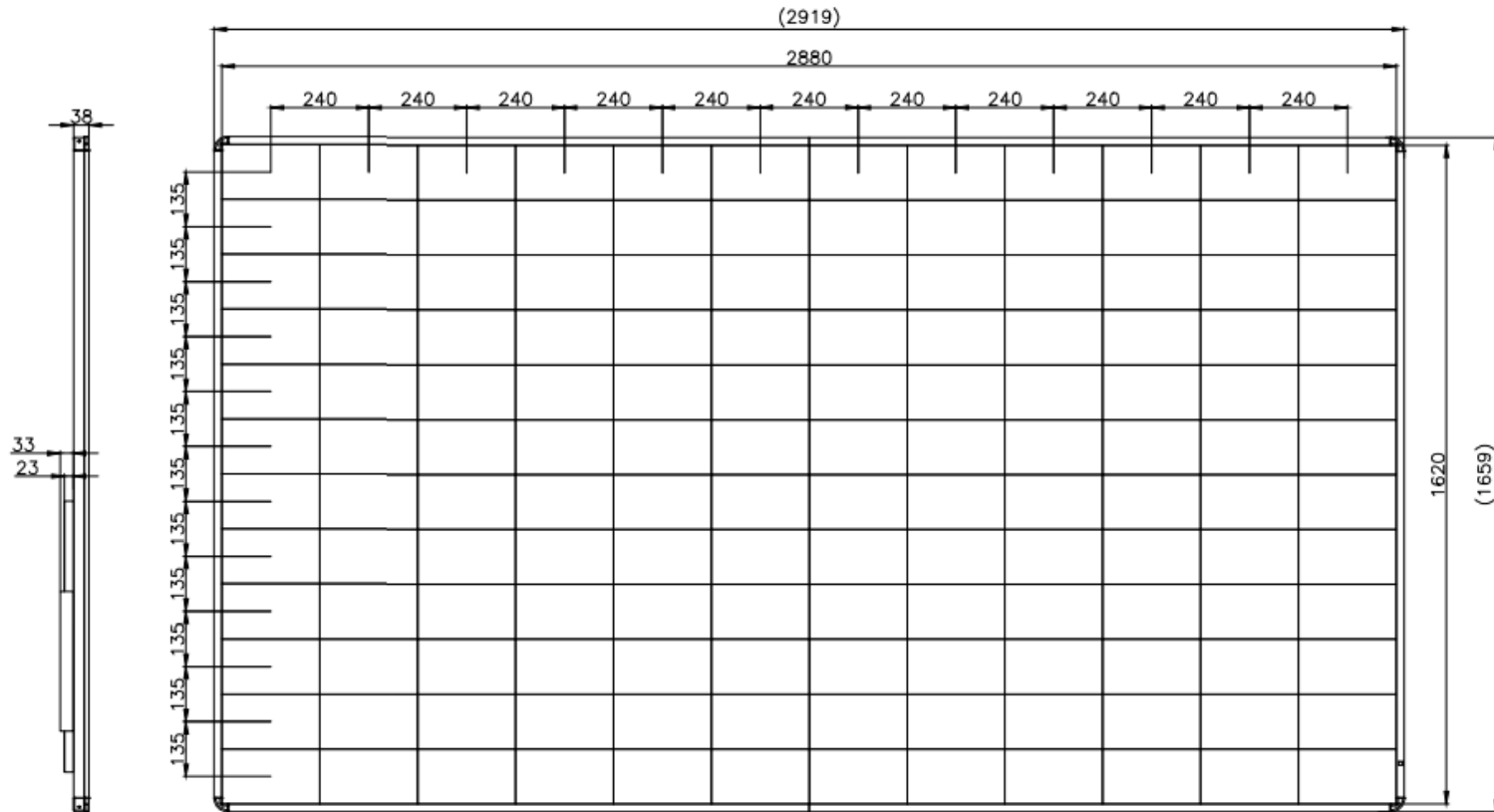

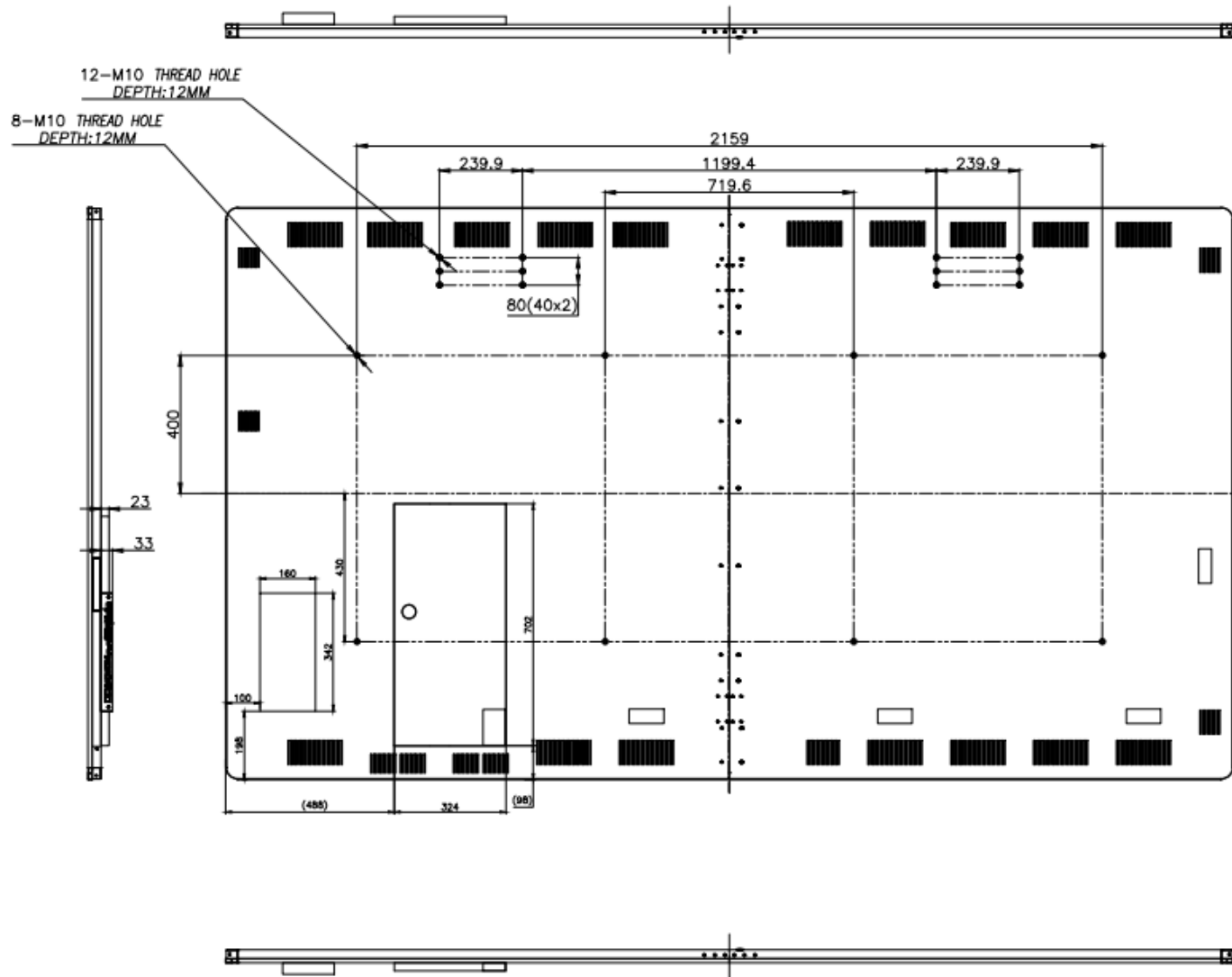

Appendix E RS232 Command List

Function	Values	Default Value	Read Command																									
			CMD					Response					Command					Response										
			Fail	Pass	Fail	Pass	CMD	Fail	Pass	Fail	Pass	CMD	Fail	Pass	Fail	Pass												
Brightness	0 ~ 100	100	~	X	X	2	1	~XX21	0~100	7E 30 30 32 31 20 30 00 to 7E 30 30 32 31 20 31 30 00	F	P	~XX125	~	X	X	1	2	5	1	7E 30 30 31 32 35 20 31 00	F			O	k	0~100	
Main Input	HDMI1	HDMI1	~	X	X	1	2	~XX12	1	7E 30 30 31 32 20 31 00	F	P	~XX121	~	X	X	1	2	1	1	7E 30 30 31 32 31 20 31 00	F			O	k	7	
	HDMI2		~	X	X	1	2	~XX12	15	7E 30 30 31 32 20 31 35 00	F	P	~XX121						1	7E 30 30 31 32 31 20 31 00	F			O	k	8		
	VGA		~	X	X	1	2	~XX12	5	7E 30 30 31 32 20 35 00	F	P	~XX121						1	7E 30 30 31 32 31 20 31 00	F			O	k	2		
	3G-SDI		~	X	X	1	2	~XX12	22	7E 30 30 31 32 20 32 32 00	F	P	~XX121						1	7E 30 30 31 32 31 20 31 00	F			O	k	18		
	HDBaseT		~	X	X	1	2	~XX12	21	7E 30 30 31 32 20 32 31 00	F	P	~XX121						1	7E 30 30 31 32 31 20 31 00	F			O	k	16		
PIP Input	Multimedia	HDMI2	~	X	X	1	2	~XX12	23	7E 30 30 31 32 20 32 33 00	F	P	~XX121						1	7E 30 30 31 32 31 20 31 00	F			O	k	17		
	HDMI1		~	X	X	3	0	5	~XX305	1	7E 30 30 33 30 35 20 31 00	F	P	~XX131	~	X	X	1	3	1	1	7E 30 30 31 33 31 20 31 00	F			O	k	7
	HDMI2		~	X	X	3	0	5	~XX305	4	7E 30 30 33 30 35 20 34 00	F	P	~XX131	~	X	X	1	3	1	1	7E 30 30 31 33 31 20 31 00	F			O	k	8
	VGA		~	X	X	3	0	5	~XX305	2	7E 30 30 33 30 35 20 32 00	F	P	~XX131	~	X	X	1	3	1	1	7E 30 30 31 33 31 20 31 00	F			O	k	2
	HDBaseT		~	X	X	3	0	5	~XX305	10	7E 30 30 33 30 35 20 31 30 00	F	P	~XX131	~	X	X	1	3	1	1	7E 30 30 31 33 31 20 31 00	F			O	k	16
PIP Input	Off	Off	~	X	X	3	0	2	~XX302	0	7E 30 30 33 30 32 20 30 00	F	P															
	Enable		~	X	X	3	0	2	~XX302	1	7E 30 30 33 30 32 20 31 00	F	P															
PIP Location	PIP-Bottom Right	PIP-Top Left	~	X	X	3	0	3	~XX303	4	7E 30 30 33 30 33 20 34 00	F	P															
	PIP-Bottom Left		~	X	X	3	0	3	~XX303	3	7E 30 30 33 30 33 20 33 00	F	P															
	PIP-Top Left		~	X	X	3	0	3	~XX303	1	7E 30 30 33 30 33 20 31 00	F	P															
	PIP-Top Right		~	X	X	3	0	3	~XX303	2	7E 30 30 33 30 33 20 32 00	F	P															
PIP Size	Large	Large	~	X	X	3	0	4	~XX304	1	7E 30 30 33 30 34 20 31 00	F	P															
	Medium		~	X	X	3	0	4	~XX304	2	7E 30 30 33 30 34 20 32 00	F	P															
	Small		~	X	X	3	0	4	~XX304	3	7E 30 30 33 30 34 20 33 00	F	P															
Audio	0 ~ 15	15	~	X	X	8	1	~XX81	0~15	7E 30 30 38 31 20 30 00 to 7E 30 30 38 31 20 31 35 00	F	P																
Phase	0 ~ 31	0	~	X	X	7	4	~XX74	0~31	7E 30 30 37 34 20 30 00 to 7E 30 30 37 34 20 31 00	F	P																
Factory Reset	1		~	X	X	1	1	2	~XX112	1	7E 30 30 31 31 32 20 31 00	F	P															
Power On	1		~	X	X	0	0		~XX00	1	7E 30 30 30 30 20 31 00	F	P	~XX124	~	X	X	1	2	4	1	7E 30 30 31 32 34 20 31 00	F			O	k	1
Power Off	0		~	X	X	0	0		~XX00	0	7E 30 30 30 30 20 30 00	F	P	~XX124	~	X	X	1	2	4	1	7E 30 30 31 32 34 20 31 00	F			O	k	0
FW Version	1												~XX122	~	X	X	1	2	2	1	7E 30 30 31 32 32 20 31 00	F			O	k	nnnn	

Appendix F WiFi Password

123456789